

# Shenzhen SOFARSOLAR Co., Ltd. TEST REPORT

**SCOPE OF WORK**

EMC TESTING– SOFAR 10000TL-G2, SOFAR 12000TL-G2, SOFAR 15000TL-G2

**REPORT NUMBER**

190411096GZU-001

**ISSUE DATE**

08-July-2019

**[REVISED DATE]**

[15-April-2020]

**PAGES**

67

**DOCUMENT CONTROL NUMBER**

EN 61000-6-1, 6-3-b

© 2017 INTERTEK



## TEST REPORT

Telephone: 86-20-8213 9688  
Facsimile: 86-20-3205 7538  
[www.intertek.com](http://www.intertek.com)

Applicant Name & Address : Shenzhen SOFARSOLAR Co., Ltd.  
401, Building 4, AnTongDa Industrial Park, District 68, XingDong  
Community, XinAn Street, BaoAn District, Shenzhen, China  
Manufacturing Site : Same as applicant  
Intertek Report No: 190411096GZU-001 amendment 1

## Test standards

**EN 61000-6-1:2007/ IEC 61000-6-1:2005**  
**EN 61000-6-3:2007+A1:2011/IEC 61000-6-3:2006+A1:2010**

## Sample Description

Product : Solar Grid-tied Inverter  
Model No. : SOFAR 10000TL-G2, SOFAR 12000TL-G2, SOFAR 15000TL-G2  
Electrical Rating : See page 7  
Serial No. : Not Labeled  
Date Received : 09 June 2019  
Date Test : 11 June 2019-26 June 2019  
Conducted

Prepared and Checked By

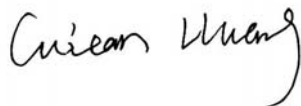

Guitar Huang  
Project Engineer  
Intertek Guangzhou

Approved By:



Strong Yao  
Manager  
Intertek Guangzhou

This report is for the exclusive use of Intertek's Client and is provided pursuant to the agreement between Intertek and its Client. Intertek's responsibility and liability are limited to the terms and conditions of the agreement. Intertek assumes no liability to any party, other than to the Client in accordance with the agreement, for any loss, expense or damage occasioned by the use of this report. Only the Client is authorized to permit copying or distribution of this report and then only in its entirety. Any use of the Intertek name or one of its marks for the sale or advertisement of the tested material, product or service must first be approved in writing by Intertek. The observations and test results in this report are relevant only to the sample tested. This report by itself does not imply that the material, product, or service is or has ever been under an Intertek certification program.

**TEST REPORT**

**CONTENT**

<b>CONTENT</b> .....	<b>3</b>
<b>1. TEST RESULTS SUMMARY</b> .....	<b>5</b>
<b>2. EMC RESULTS CONCLUSION</b> .....	<b>6</b>
<b>3. LABORATORY MEASUREMENTS</b> .....	<b>8</b>
<b>4. EQUIPMENT USED DURING TEST</b> .....	<b>9</b>
<b>5. EMI TEST</b> .....	<b>13</b>
5.1 EN 61000-6-3 CONTINUOUS CONDUCTED DISTURBANCE VOLTAGE TEST .....	13
5.1.1 <i>Block Diagram of Test Setup</i> .....	13
5.1.2 <i>Test Setup and Procedure</i> .....	13
5.1.3 <i>Test Data and curve</i> .....	14
5.2 EN 61000-6-3 DISCONTINUOUS CONDUCTED DISTURBANCE VOLTAGE .....	18
5.3 EN 61000-6-3 EMISSION AT TELECOMMUNICATIONS/NETWORK PORTS.....	18
5.3.1 <i>Block Diagram of Test Setup</i> .....	18
5.3.2 <i>Test Setup and Procedure</i> .....	18
5.3.3 <i>Test Data and curve</i> .....	19
5.4 EN 61000-6-3 RADIATED EMISSION BELOW 1 GHZ.....	20
5.4.1 <i>Block Diagram of Test Setup</i> .....	20
5.4.2 <i>Test Setup and Procedure</i> .....	20
5.4.3 <i>Test Data and Curve</i> .....	21
5.5 EN 61000-6-3 RADIATED EMISSION ABOVE 1 GHZ.....	23
<b>6. HARMONICS OF CURRENT</b> .....	<b>24</b>
6.1 BLOCK DIAGRAM OF TEST SETUP .....	24
6.2 TEST SETUP AND PROCEDURE.....	24
6.3 TEST DATA.....	24
<b>7. FLICKER</b> .....	<b>37</b>
7.1 BLOCK DIAGRAM OF TEST SETUP .....	37
7.2 TEST SETUP AND PROCEDURE.....	37
7.3 TEST DATA.....	38
<b>8. EMS TEST</b> .....	<b>42</b>
8.1 EN 61000-4-2(PURSUANT TO EN 61000-6-1) ELECTROSTATIC DISCHARGE IMMUNITY .....	42
8.2 EN 61000-4-6(PURSUANT TO EN 61000-6-1) INJECTED CURRENT (0.15 MHZ TO 80 MHZ)	45
8.3 EN 61000-4-4(PURSUANT TO EN 61000-6-1) ELECTRICAL FAST TRANSIENT/BURST.....	46
8.4 EN 61000-4-5(PURSUANT TO EN 61000-6-1) SURGE IMMUNITY .....	47
8.5 EN 61000-4-11(PURSUANT TO EN 61000-6-1) VOLTAGE DIPS AND INTERRUPTIONS .....	48
8.6 EN 61000-4-3(PURSUANT TO EN 61000-6-1) RADIATED ELECTROMAGNETIC FIELD IMMUNITY	49
8.7 EN 61000-4-8(PURSUANT TO EN 61000-6-1) POWER FREQUENCY MAGNETIC FIELD	
IMMUNITY.....	52
<b>9. APPENDIX I - PHOTOS OF TEST SETUP</b> .....	<b>54</b>

**TEST REPORT**

**10. APPENDIX II – PHOTOS OF EUT ..... 59**

## TEST REPORT

### 1. TEST RESULTS SUMMARY

Test Item	Standard	Result
Continuous conducted disturbance voltage	EN 61000-6-3:2007+A1:2011 Reference: EN 55016-2-1:2009	Pass
Discontinuous conducted disturbance voltage	EN 61000-6-3:2007+A1:2011 Reference: EN 55014-1:2006+A1:2009	N/A
Emission at Telecommunications / network Ports	EN 61000-6-3:2007+A1:2011 Reference: EN 55022:2010	Pass
Radiated emission (30 MHz–1000 MHz)	EN 61000-6-3:2007+A1:2011 Reference: EN 55016-2-3:2010	Pass
Radiated emission (1 GHz–6 GHz)	EN 61000-6-3:2007+A1:2011 Reference: EN 55016-2-3:2010	N/A
Harmonic of current	EN 61000-6-3:2007+A1:2011 Reference: EN 61000-3-2:2006+A1:2009+A2:2009	Pass
Harmonic of current	EN 61000-6-3:2007+A1:2011 Reference: EN 61000-3-12 :2011	Pass
Flicker	EN 61000-6-3:2007+A1:2011 Reference: EN 61000-3-3:2008	Pass
Flicker	EN 61000-6-3:2007+A1:2011 Reference: EN 61000-3-11:2000	Pass
ESD immunity	EN 61000-6-1:2007 Reference: EN 61000-4-2:2009	Pass
Radiated EM field immunity	EN 61000-6-1:2007 Reference: EN 61000-4-3:2006 +A1:2008 + A2:2010	Pass
EFT immunity	EN 61000-6-1:2007 Reference: EN 61000-4-4:2012	Pass
Surge immunity	EN 61000-6-1:2007 Reference: EN 61000-4-5:2006	Pass
Inject current immunity	EN 61000-6-1:2007 Reference: EN 61000-4-6:2009	Pass
Power frequency magnetic field immunity	EN 61000-6-1:2007 Reference: EN 61000-4-8:2010	Pass
Voltage dips and interruption immunity	EN 61000-6-1:2007 Reference: EN 61000-4-11:2004	N/A

Remark:

1. The symbol "N/A" in above table means Not Applicable.
2. When determining the test results, measurement uncertainty of tests has been considered.

## TEST REPORT

### 2. EMC RESULTS CONCLUSION

RE: EMC Testing Pursuant to EMC Directive 2014/30/EU performed on the Solar Grid-tied Inverter, Models: SOFAR 10000TL-G2, SOFAR 12000TL-G2, SOFAR 15000TL-G2

The model SOFAR 10000TL-G2, SOFAR 12000TL-G2 and SOFAR 15000TL-G2 are completely identical, except output power derating in software.

Based on above difference and engineering judgement, We performed the Solar Grid-tied Inverter, representative model SOFAR 15000TL-G2 in full EMI and EMS tests, and additional Harmonic of current and Flicker test on model SOFAR 10000TL-G2 due to the different rated current.

Report revision reason:

This report is the revision of the previous test report 190411096GZU-001 dated 08-July-2019 and shall replace it.

This report was issued because of the following change:

1. Added the IEC 61000-6-1:2005 which is same as standard EN 61000-6-1: 2007
2. Added the IEC 61000-6-3:2006+A1:2010 standard is same as standard EN 61000-6-3:2007+A1:2011

Based on above changes and engineering judgement, no any test was performed therefore the original data was kept in the test report.

The production units are required to conform to the initial sample as received when the units are placed on the market.

**TEST REPORT**

**Electrical Rating:**

Model	SOFAR 10000TL-G2	SOFAR 12000TL-G2	SOFAR 15000TL-G2
Max.PV voltage	1000 d.c.V		
PV MPPT voltage range	160-960 d.c.V		
Max.input current	21 /11 d.c.A		
PV Isc	30/15 d.c.A		
Max.output power	10000W	12000W	15000W
Max.apparent power	11000VA	13200VA	16500VA
Nominal output voltage	3/N/PE, 230 /400 a.c.V		
Max.output current	3×16.5 a.c.A	3×20.0 a.c.A	3×24.0 a.c.A
Nominal output Frequency	50 Hz		
Power factor range	0.8Leading – 0.8 lagging		
Inverter technology	Non-isolated		
Safety level	Class I		
Ingress Protection	IP 65		
Operation Ambient Temperature	-25°C - +60°C		
Software Version	V0.21		

**TEST REPORT**

**3. LABORATORY MEASUREMENTS**

**Configuration Information**

Support Equipment: N/A

Rated Voltage and frequency under test: See page 7

Condition of Environment: Temperature: 22~28°C  
Relative Humidity:35~60%  
Atmosphere Pressure:86~106kPa

**Notes:**

1. The EMI measurements had been made in the operating mode produced the largest emission in the frequency band being investigated consistent with normal applications. An attempt had been made to maximize the emission by varying the configuration of the EUT.

2. The EMS measurements had been made in the frequency bands being investigated, with the EUT in the most susceptible operating mode consistent with normal applications. The configuration of the test sample had been varied to achieve maximum susceptibility.

3. Test Location:

All tests were performed at:  
Shenzhen EMTEK Co.,Ltd.  
Bldg. 69, Majialong Industry Zone, Nanshan District, Shenzhen,Guangdong,China.  
Except the ESD immunity was performed at  
Intertek Testing Services Shenzhen Ltd. Guangzhou Branch  
Block E, No.7-2 Guang Dong Software Science Park, Caipin Road, Guangzhou Science City,  
GETDD Guangzhou, China

4.Measurement Uncertainty

No.	Item	Measurement Uncertainty
1	Conduction Emission (9 kHz-150 kHz)	2.96 dB
2	Conduction Emission (150 kHz-30 MHz)	2.74dB
3	Disturbance Power (30 MHz-300 MHz)	2.53dB
4	Radiated Emission (30 MHz-1 GHz)	H: 3.96dB; V: 4.04dB
5	Radiated Emission (1 GHz-6 GHz)	4.46dB
6	Radiated Emission (6 GHz-18 GHz)	4.96dB

The measurement uncertainty describes the overall uncertainty of the given measured value during the operation of the EUT.

Measurement uncertainty is calculated in accordance with CISPR16-4-2:2011

The measurement uncertainty is given with a confidence of 95%, k=2.



**TEST REPORT**

**4. EQUIPMENT USED DURING TEST**

<b>Conducted Disturbance-Mains Terminal</b>				
<b>Equipment No.</b>	<b>Equipment</b>	<b>Model</b>	<b>Manufacturer</b>	<b>Calibration Interval</b>
EE020	Test Receiver	ESCS30	Rohde & Schwarz	1Y
EE156	L.I.S.N.	NNLK8129	Schwarzbeck	1Y
EE020-3	50Ω Coaxial Switch	MP59B	Anritsu	1Y
EE020-1	Pulse Limiter	ESH3-Z2	Rohde & Schwarz	1Y

**Emission at Telecommunications/network Ports**

<b>Equipment No.</b>	<b>Equipment</b>	<b>Model</b>	<b>Manufacturer</b>	<b>Calibration Interval</b>
EE144	Test Receiver	ESCI	Rohde & Schwarz	1Y
EE171	I.S.N	ISN T800	Teseq GmbH	1Y
EE267	I.S.N	T8-CAT6	Teseq GmbH	1Y
EE041	50Ω Coaxial Switch	MP59B	Anritsu	1Y

**TEST REPORT**

Radiated Emission below 1 GHz				
Equipment No.	Equipment	Model	Manufacturer	Calibration Interval
EE226	EMI Test Receiver	ESR3	Rohde & Schwarz	1Y
EE249	EMI Test Receiver	ESR3	Rohde & Schwarz	1Y
EE264	Pre-Amplifier	LNA 10M1G-40	Lunar EM	1Y
EE263	Pre-Amplifier	LNA 10M1G-40	Lunar EM	1Y
EE231	Bilog Antenna	VULB9163	Schwarzbeck	1Y
EE246	Bilog Antenna	VULB9163	Schwarzbeck	1Y
EE318	Cable	LMR-240 N-N 1m	Times Microwave	1Y
EE319	Cable	LMR-240 N-N 1m	Times Microwave	1Y
EE320	Cable	LMR-240 N-N 1.5m	Times Microwave	1Y
EE321	Cable	LMR-240 N-N 1.5m	Times Microwave	1Y
EE323	Cable	LMR-240 N-N 12m	Times Microwave	1Y
EE322	Cable	LMR-240 N-N 11m	Times Microwave	1Y

**Harmonic Currents and Flicker(1)**

Equipment No.	Equipment	Model	Manufacturer	Calibration Interval
EE206	45KVA AC Power source	NSG 1007- 45/45KVA	Teseq	1Y
EE206-1	Signal conditioning Unit	CCN 1000-3	Teseq	1Y
EE206-2	Three phase impedance network	INA2197/37A	Teseq/Germany	1Y
EE206-3	Three phase impedance network	INA 2196/75A	Teseq/Germany	1Y
EE207	Proflin 2100 AC Switching Unit	NSG2200-3	Teseq/Germany	1Y

**Electrostatic Discharge (1)**

Equipment No.	Equipment	Model	Manufacturer	Calibration Interval
EM077-04	ESD Simulator	NSG437	TESEQ	1Y
SA047-143	Digital Temperature-Humidity Recorder	AW5145Y	ASAIR	1Y

## TEST REPORT

Radiated Electromagnetic Field Immunity				
Equipment No.	Equipment	Model	Manufacturer	Calibration Interval
EE218	Signal Generator	N5181A	Agilent	1Y
EE066-6	RF Power Meter. Dual Channel	4232A	BOONTON	1Y
EE066-4	50ohm Diode Power Sensor	51011EMC	BOONTON	1Y
EE221	Field Strength Meter	RSS1006A	DARE	1Y
EE219	50ohm Diode Power Sensor	51011EMC	BOONTON	1Y
EE066-1	Power Amplifier	80RF1000-175	MILMEGA	1Y
EE066-2	Power Amplifier	AS0102-55	MILMEGA	1Y
EE224	Power Amplifier	AS1860-50	MILMEGA	1Y
EE067	Log.-Per. Antenna	VULP 9118E	SCHWARZBECK	1Y
EE220	Broad-Band Horn Antenna	STLP 9149	SCHWARZBECK	1Y
EE222	Multi-function interface system	CTR1009B	DARE	1Y
EE223	Automatic switch group	RSW1004A	DARE	1Y

Electrical Fast Transient/Burst				
Equipment No.	Equipment	Model	Manufacturer	Calibration Interval
EE014	Burst Tester	PEFT4010	HAEFELY	1Y
EE015	Coupling Clamp	IP-4A	HAEFELY	1Y
EE205	Three phase CDN	CDN 163	Teseq	1Y

Surge				
Equipment No.	Equipment	Model	Manufacturer	Calibration Interval
EE162	Surge Controller	Psurge 8000	HAEFELY	1Y
EE162-1	Impulse Module	PIM 100	HAEFELY	1Y
EE162-2	Coupling Decoupling Filter	PCD 130	HAEFELY	1Y
EE162-3	Coupling Module	PCD122	HAEFELY	1Y
EE162-4	Surge Impulse Module	PIM 120	HAEFELY	1Y
EE162-5	Coupling Module	PCD 126A	HAEFELY	1Y
EE162-6	Impulse Module	PIM 110	HAEFELY	1Y
EE162-7	Impulse Module	PIM 150	HAEFELY	1Y

**TEST REPORT**

Conducted Susceptibility				
Equipment No.	Equipment	Model	Manufacturer	Calibration Interval
EM003-01	Conducted Disturbance Generator	CDG_1020	Dr.Hubert GmbH	1Y
EE350	Simulator	CIT-10	FRANKONIA	1Y
EE007-2	CDN	CDN-M2	EMTEST	1Y
EE007-3	CDN	CDN-M3	EMTEST	1Y
EE007-4	Injection Clamp	F-2031-23MM	EMTEST	1Y
EE007-5	Attenuator	ATT6	EMTEST	1Y
EE204	Three phase CDN	CDN M332S	Teseq	1Y
EE204-1	Three phase CDN	CDN M432S	Teseq	1Y
EE204-2	Three phase CDN	CDN M432-3LNS	Teseq	1Y
EE146	Three phase CDN	CDN M532S	Teseq	1Y
EE345	Bulk Current Injection Probe	F-120-9	FCC	1Y

Power Frequency Magnetic Field Immunity				
Equipment No.	Equipment	Model	Manufacturer	Calibration Interval
EE006	Magnetic Field Tester	MAG100	HAEFELY	1Y

## TEST REPORT

### 5. EMI TEST

#### 5.1 EN 61000-6-3 Continuous Conducted Disturbance Voltage Test

**Test Result: Pass**

##### 5.1.1 Block Diagram of Test Setup

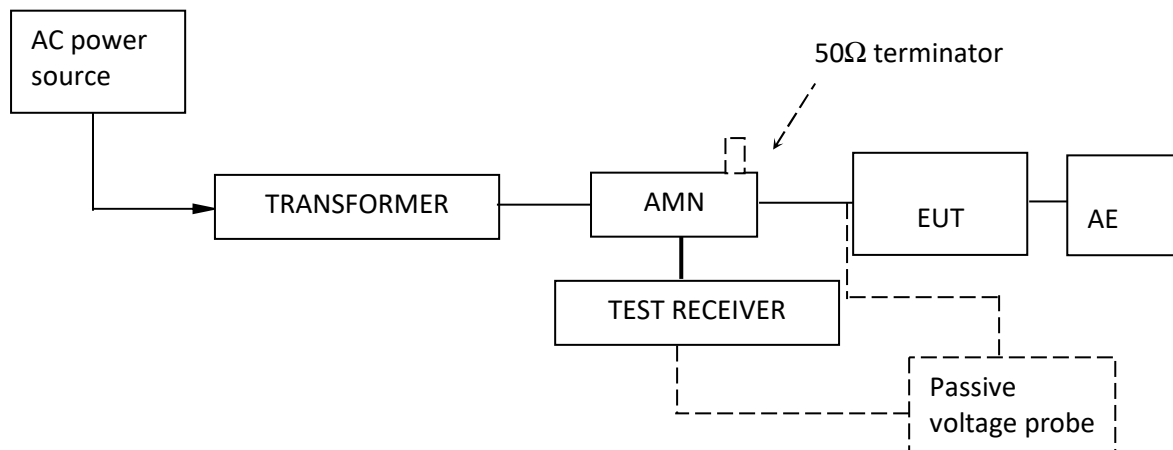

##### 5.1.2 Test Setup and Procedure

The EUT was set to achieve the maximum emission level. The mains terminal disturbance voltage was measured with the EUT in a shielded room. The EUT was connected to AC power source through an Artificial Mains Network which provides a 50Ω linear impedance artificial hand is used if appropriate (for handheld apparatus). The load/control terminal disturbance voltage was measured with passive voltage probe if appropriate.

The table-top EUT was placed on a 0.8m high non-metallic table above earthed ground plane (Ground Reference Plane). And for floor standing EUT, was placed on a 0.1m high non-metallic supported on GRP. The EUT keeps a distance of at least 0.4m from a vertical metallic surface. The Artificial Mains Network is situated at a distance of 0.8m from the EUT.

During the test, mains lead of EUT excess 0.8m was folded back and forth parallel to the lead so as to form a horizontal bundle with a length between 0.3m and 0.4m.

The bandwidth of test receiver was set at 9 kHz. The frequency range from 150 kHz to 30 MHz was checked.

**TEST REPORT**

**5.1.3 Test Data and curve**

At mains terminal:

Tested Wire: Live 1

Operation Mode: Inverting mode with full load

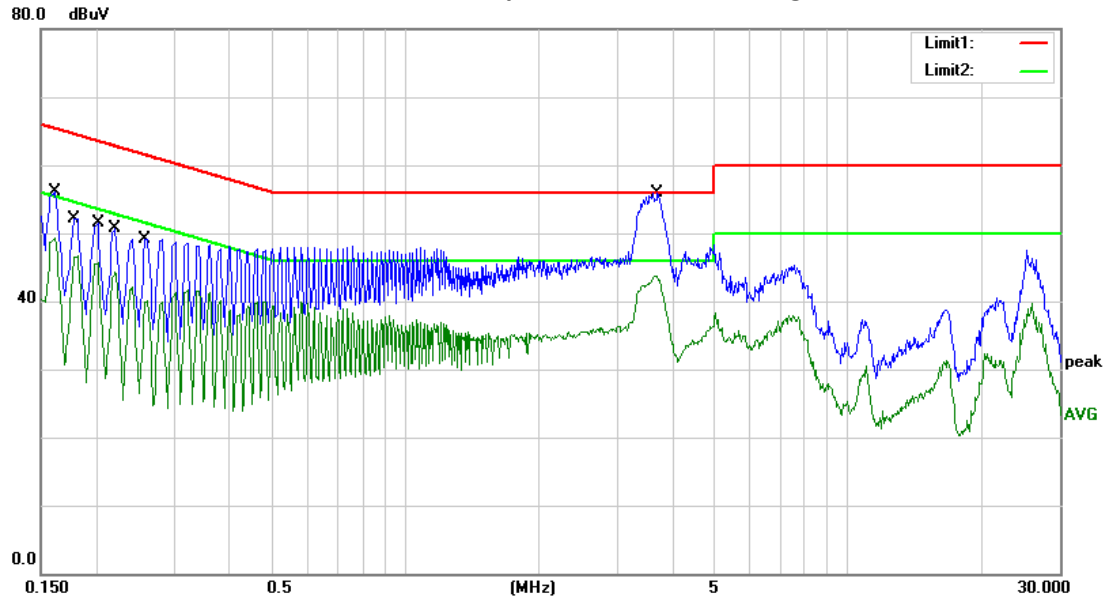

No.	Mk.	Freq.	Reading Level	Correct Factor	Measurement	Limit	Over	Detector
		MHz	dBuV	dB	dBuV	dBuV	dB	
1		0.1620	46.11	9.90	56.01	65.36	-9.35	QP
2		0.1620	39.38	9.90	49.28	55.36	-6.08	AVG
3		0.1780	42.19	9.90	52.09	64.58	-12.49	QP
4		0.1780	36.79	9.90	46.69	54.58	-7.89	AVG
5		0.2020	41.58	9.90	51.48	63.53	-12.05	QP
6		0.2020	35.72	9.90	45.62	53.53	-7.91	AVG
7		0.2220	40.72	9.90	50.62	62.74	-12.12	QP
8		0.2220	34.31	9.90	44.21	52.74	-8.53	AVG
9		0.2580	39.19	9.91	49.10	61.50	-12.40	QP
10		0.2580	30.25	9.91	40.16	51.50	-11.34	AVG
11		3.7020	41.26	9.94	51.20	56.00	-4.80	QP
12	*	3.7020	33.73	9.94	43.67	46.00	-2.33	AVG

**TEST REPORT**

Tested Wire: Live 2

Operation Mode: Inverting mode with full load

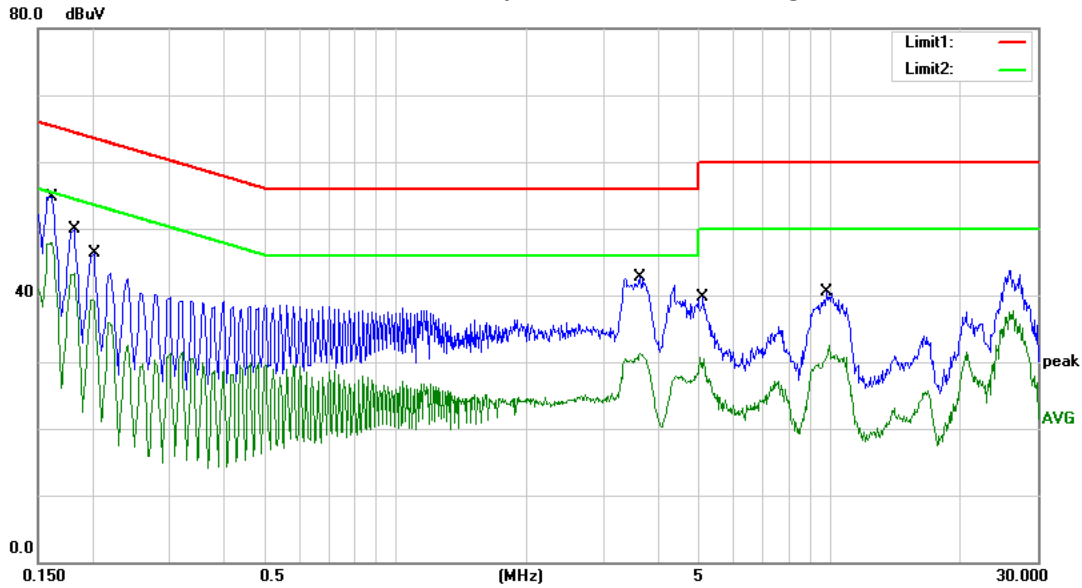

No.	Mk.	Freq. MHz	Reading Level dBuV	Correct Factor dB	Measure- ment dBuV	Limit dBuV	Over dB	Detector
1		0.1620	44.79	9.90	54.69	65.36	-10.67	QP
2	*	0.1620	37.98	9.90	47.88	55.36	-7.48	AVG
3		0.1820	39.92	9.90	49.82	64.39	-14.57	QP
4		0.1820	33.39	9.90	43.29	54.39	-11.10	AVG
5		0.2020	36.44	9.90	46.34	63.53	-17.19	QP
6		0.2020	29.43	9.90	39.33	53.53	-14.20	AVG
7		3.6540	32.71	9.94	42.65	56.00	-13.35	QP
8		3.6540	21.35	9.94	31.29	46.00	-14.71	AVG
9		5.1100	29.75	9.95	39.70	60.00	-20.30	QP
10		5.1100	20.79	9.95	30.74	50.00	-19.26	AVG
11		9.8540	30.49	10.01	40.50	60.00	-19.50	QP
12		9.8540	22.46	10.01	32.47	50.00	-17.53	AVG

## TEST REPORT

Tested Wire: Live 3

Operation Mode: Inverting mode with full load

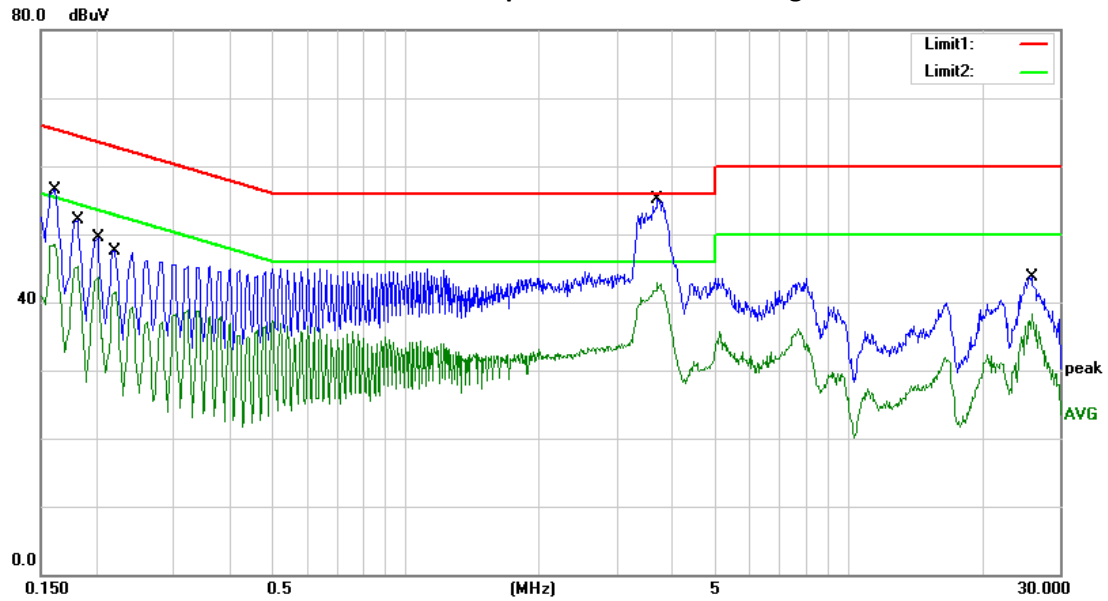

No.	Mk.	Freq. MHz	Reading Level dBuV	Correct Factor dB	Measure- ment dBuV	Limit dBuV	Over dB	Detector
1		0.1620	46.65	9.90	56.55	65.36	-8.81	QP
2		0.1620	38.54	9.90	48.44	55.36	-6.92	AVG
3		0.1820	42.16	9.90	52.06	64.39	-12.33	QP
4		0.1820	35.43	9.90	45.33	54.39	-9.06	AVG
5		0.2020	39.58	9.90	49.48	63.53	-14.05	QP
6		0.2020	33.76	9.90	43.66	53.53	-9.87	AVG
7		0.2220	37.69	9.90	47.59	62.74	-15.15	QP
8		0.2220	31.57	9.90	41.47	52.74	-11.27	AVG
9		3.7020	40.26	9.94	50.20	56.00	-5.80	QP
10	*	3.7020	32.88	9.94	42.82	46.00	-3.18	AVG
11		25.9700	33.37	10.29	43.66	60.00	-16.34	QP
12		25.9700	27.99	10.29	38.28	50.00	-11.72	AVG



**TEST REPORT**

**Tested Wire: Neutral**

**Operation Mode: Inverting mode with full load**

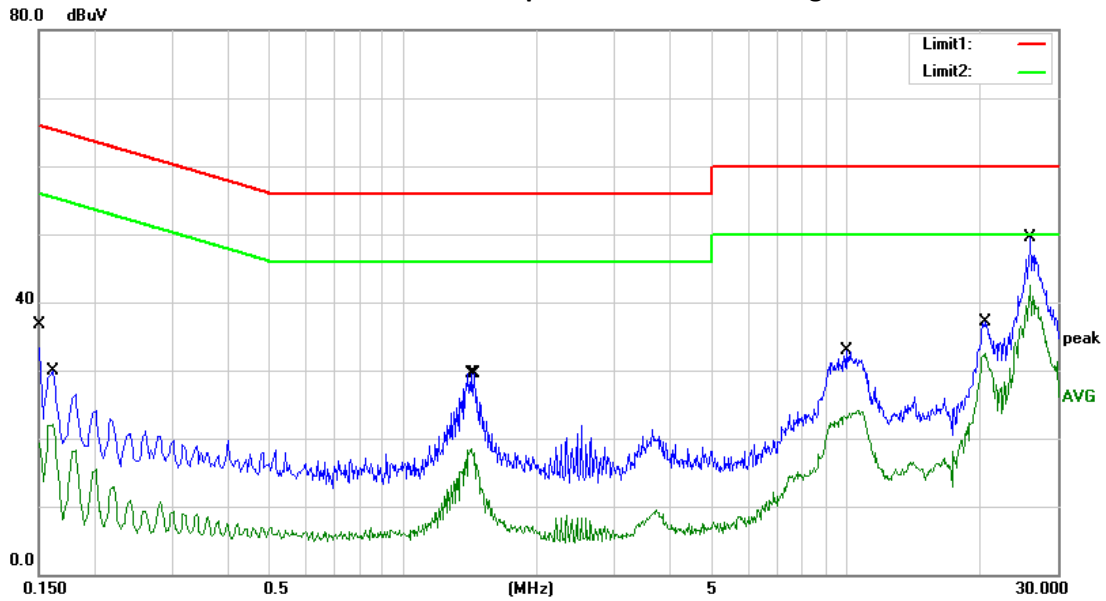

No.	Mk.	Freq. MHz	Reading Level dBµV	Correct Factor dB	Measure- ment dBµV	Limit dBµV	Over dB	Detector
1		0.1500	26.75	9.89	36.64	66.00	-29.36	QP
2		0.1500	10.92	9.89	20.81	56.00	-35.19	AVG
3		0.1620	20.00	9.90	29.90	65.36	-35.46	QP
4		0.1620	12.11	9.90	22.01	55.36	-33.35	AVG
5		1.4220	8.51	9.93	18.44	46.00	-27.56	AVG
6		1.4420	19.64	9.93	29.57	56.00	-26.43	QP
7		9.9660	22.92	10.01	32.93	60.00	-27.07	QP
8		9.9660	13.73	10.01	23.74	50.00	-26.26	AVG
9		20.4900	26.95	10.10	37.05	60.00	-22.95	QP
10		20.4900	22.49	10.10	32.59	50.00	-17.41	AVG
11		26.0140	39.25	10.29	49.54	60.00	-10.46	QP
12	*	26.0140	32.27	10.29	42.56	50.00	-7.44	AVG

Remark:

1. Corr. (dB) = LISN Factor (dB) + Cable Loss (dB)
2. Level (dBµV) = Corr. (dB) + Read Level (dBµV)
3. Delta Limit (dB) = Level (dBµV)-Limit (dBµV)

## TEST REPORT

### 5.2 EN 61000-6-3 Discontinuous Conducted Disturbance Voltage

**Test Result: Not applicable**

### 5.3 EN 61000-6-3 Emission at Telecommunications/network Ports

**Test Result: Pass**

Remark: The test only apply to balanced telecommunication ports intended for connection to unscreened balanced pairs

#### 5.3.1 Block Diagram of Test Setup

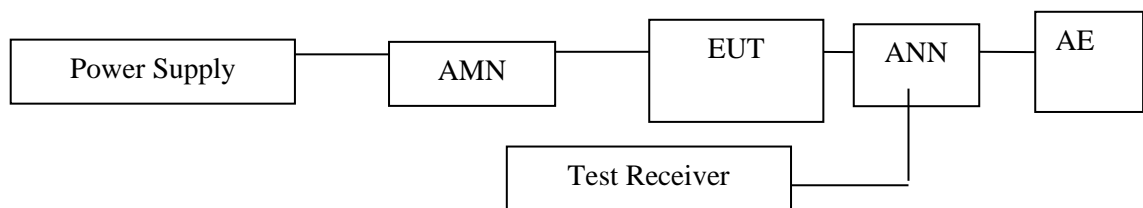

#### 5.3.2 Test Setup and Procedure

The EUT, local AE and associated cabling were arranged in the most compact practical arrangement. The measurement was performed using a vertical GRP. The rear of the EUT, local AE and associated cabling were 0.4m from the vertical GRP. All ground planes in use were bonded together. AMN(s) and AAN(s) in use were bonded to either the vertical RGP or other metal planes bonded to it.

During measurements on analogue/digital data ports, the mains cable of the unit being assessed was connected to one AMN. All other units of the EUT and AE were connected to a second (or multiple) AMN(s) which provide a 50Ω linear impedance. The AAN used had a 150Ω linear impedance. The cable between the EUT and AAN device or probe was 0.8m, spacing between AAN and local AE was more than 0.8m. In the case of EUTs including floor standing equipment the cable connecting the analogue/digital data port to the AAN was positioned perpendicular to the EUT for a distance between of 0,3 m and 0,8 m then drop vertically to the horizontal RGP before being extended to the AMN/AAN. In these cases any bundling was located on the ground plane.

For ports supporting Ethernet traffic (for example 100Base-T, 1000Base-T), that could operate at multiple rates, measurements were limited to mode in which the EUT operates at its maximum rate.

When assessing an EUT transmitting 10Base-T Ethernet traffic, applied the following:  
In order to make reliable emission measurements representative of high LAN utilization it was only necessary to create a condition of LAN utilization in excess of 10 % and sustain that level for a minimum of 250 ms. The content of the test traffic should consist of both periodic and pseudo-random messages in order to emulate realistic types of data transmission.

**TEST REPORT**

**5.3.3 Test Data and curve**

Test port: LAN  
100.0 dBuV

Operation Mode: Communication with PC

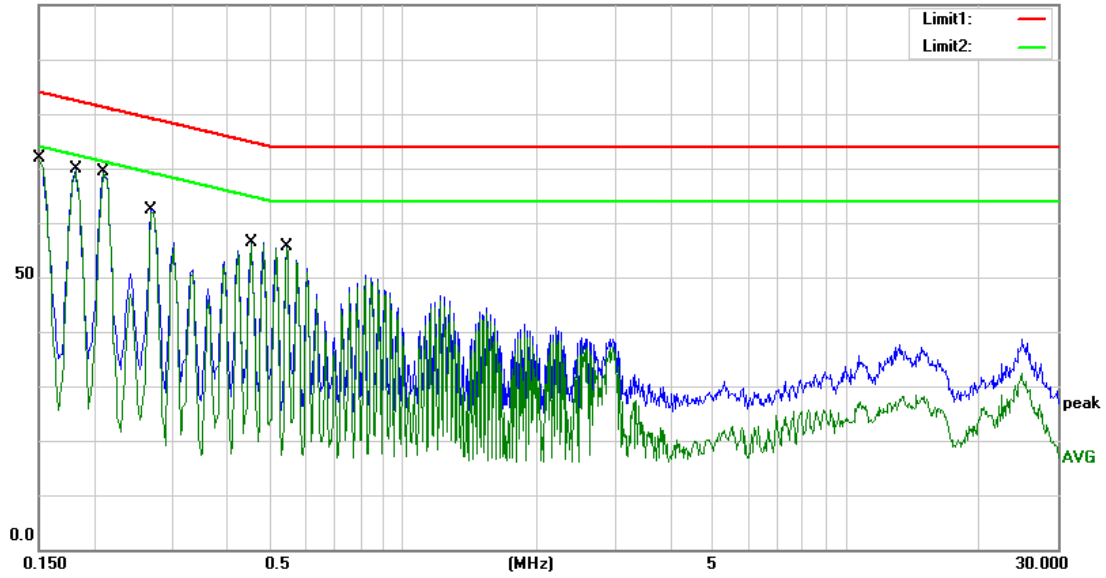

No.	Mk.	Freq. MHz	Reading Level dBuV	Correct Factor dB	Measure- ment dBuV	Limit dBuV	Over dB	Detector
1		0.1500	62.06	9.89	71.95	84.00	-12.05	QP
2		0.1500	61.98	9.89	71.87	74.00	-2.13	AVG
3		0.1820	59.96	9.90	69.86	82.39	-12.53	QP
4		0.1820	59.71	9.90	69.61	72.39	-2.78	AVG
5		0.2100	59.37	9.90	69.27	81.21	-11.94	QP
6	*	0.2100	59.20	9.90	69.10	71.21	-2.11	AVG
7		0.2700	52.52	9.91	62.43	79.12	-16.69	QP
8		0.2700	52.01	9.91	61.92	69.12	-7.20	AVG
9		0.4540	46.54	9.92	56.46	74.80	-18.34	QP
10		0.4540	46.16	9.92	56.08	64.80	-8.72	AVG
11		0.5460	45.74	9.92	55.66	74.00	-18.34	QP
12		0.5460	45.33	9.92	55.25	64.00	-8.75	AVG

## TEST REPORT

### 5.4 EN 61000-6-3 Radiated Emission below 1 GHz

Test Result: Pass

#### 5.4.1 Block Diagram of Test Setup

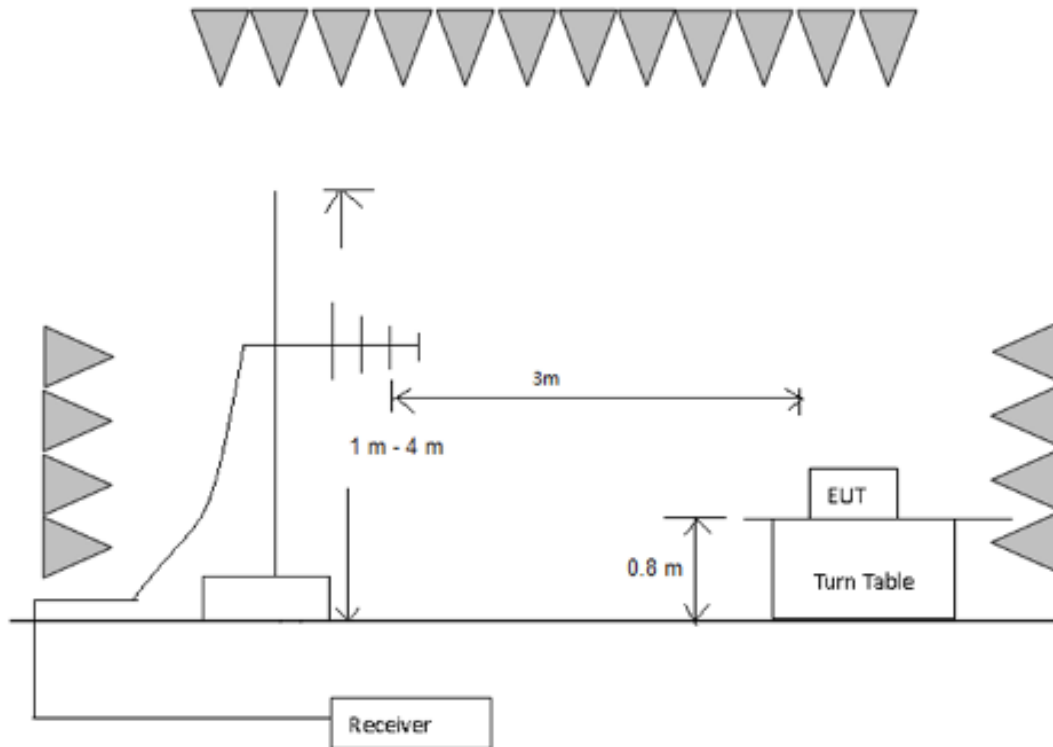

#### 5.4.2 Test Setup and Procedure

The measurement was applied in a semi-anechoic chamber. The EUT and simulators were placed on a 0.8m high wooden turntable above the horizontal metal ground plane. The turn table rotated 360 degrees to determine the position of the maximum emission level. The EUT was set 3 meters away from the receiving antenna which was mounted on an antenna mask. The antenna moved up and down between from 1meter to 4 meters to find out the maximum emission level.

Broadband antenna was used as receiving antenna. Both horizontal and vertical polarization of the antenna was set on measurement. In order to find the maximum emission, all of the interface cables were manipulated according to EN55032 requirement during radiated test. The bandwidth setting on R&S Test Receiver was 120 kHz. The frequency range from 30MHz to 1000MHz was checked

## TEST REPORT

### 5.4.3 Test Data and Curve

Operation Mode: Inverting mode with full load

Horizontal

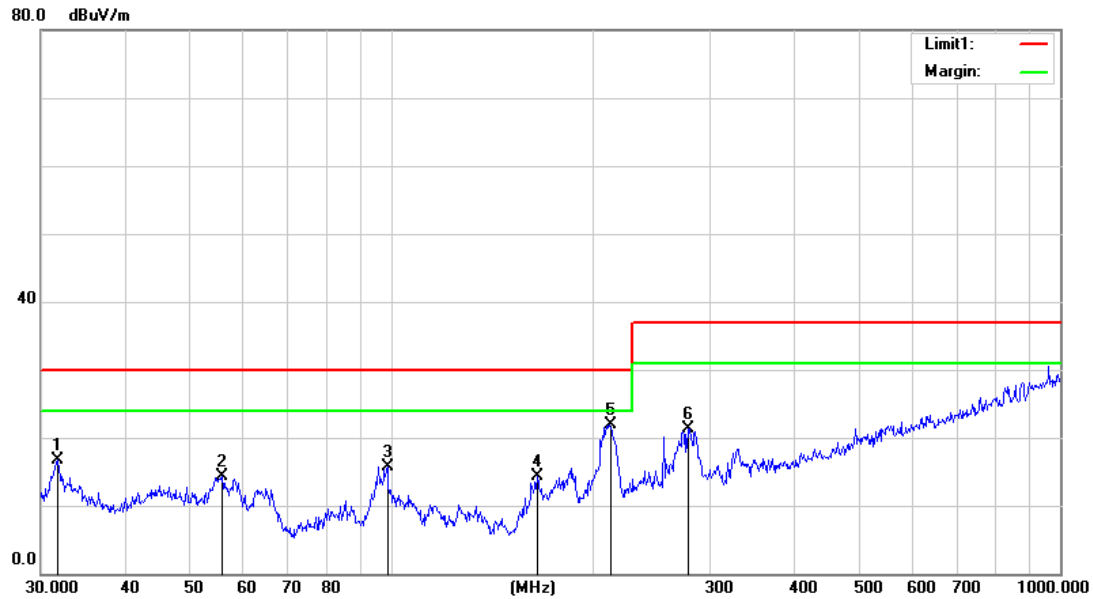

No.	Mk.	Freq.	Reading Level	Ant. Factor	Pre Amp Gain	Cable loss	Measurement	Limit	Over	HI	Degree	
		MHz	dBuV	dB/m	dB	dB	dBuV/m	dBuV/m	dB	Detector	cm	deg.
1		31.7313	48.33	10.94	43.3	0.8	16.77	30.00	-13.23	QP	199	37
2		56.0007	43.49	13.4	43.4	0.84	14.33	30.00	-15.67	QP	199	36
3		98.8326	46.19	11.77	43.59	1.38	15.75	30.00	-14.25	QP	299	108
4		165.4866	47.59	8.43	43.27	1.56	14.31	30.00	-15.69	QP	299	116
5	*	212.2695	52.42	11.05	43.04	1.52	21.95	30.00	-8.05	QP	299	344
6		278.0668	48.76	13.25	42.71	2	21.30	37.00	-15.70	QP	299	259

Remark:

1. Corr. (dB) = Antenna Factor (dB) + Cable Loss (dB)
2. Quasi Peak (dB $\mu$ V/m) = Corr. (dB) + Read Level (dB $\mu$ V)
3. Margin (dB) = Limit QPK (dB $\mu$ V/m) – Quasi Peak (dB $\mu$ V/m)

## TEST REPORT

Vertical

80.0 dBuV/m



No.	Mk.	Freq.	Reading Level	Ant. Factor	Pre Amp Gain	Cable loss	Measurement	Limit	Over	HI	Degree
		MHz	dBuV	dB/m	dB	dB	dBuV/m	dBuV/m	dB	Detector	cm
1	*	31.0706	55.44	10.89	43.02	0.99	24.30	30.00	-5.70	QP	100
2		36.8953	53.89	11.85	43.05	1.01	23.70	30.00	-6.30	QP	199
3		47.4918	52.16	13.9	43.11	1.05	24.00	30.00	-6.00	QP	299
4		63.5356	54.20	11.61	43.2	1.28	23.89	30.00	-6.11	QP	199
5		82.9385	56.89	7.91	43.31	1.61	23.10	30.00	-6.90	QP	199
6		97.4560	53.80	11.14	43.39	1.85	23.40	30.00	-6.60	QP	199

Remark:

1. Corr. (dB) = Antenna Factor (dB) + Cable Loss (dB)
2. Quasi Peak (dBμV/m) = Corr. (dB) + Read Level (dBμV)
3. Margin (dB) = Limit QPK (dBμV/m) – Quasi Peak (dBμV/m)

## TEST REPORT

### 5.5 EN 61000-6-3 Radiated Emission above 1 GHz

**Test Result: Not Applicable**

**Remark:**

The highest internal source of the EUT is not more than 108 MHz, so the measurement above 1000 MHz is not applicable.

## TEST REPORT

### 6. Harmonics of current

Test Result: Pass

#### 6.1 Block Diagram of Test Setup

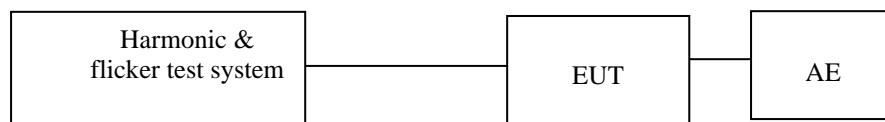

#### 6.2 Test Setup and Procedure

Harmonics of the fundamental current were measured up to 40 order harmonics using a digital power meter with an analogue output and frequency analyzer which was integrated in the harmonic & flicker test system. The measurements were carried out under steady conditions.

#### 6.3 Test Data



**TEST REPORT**

**Model: SOFAR 15000TL-G2**

Operation Mode: Inverting mode with full load

Harmonics – Per EN/IEC61000-3-12(Run time)

Test Result: Pass

Source qualification: Normal

Current & voltage waveforms

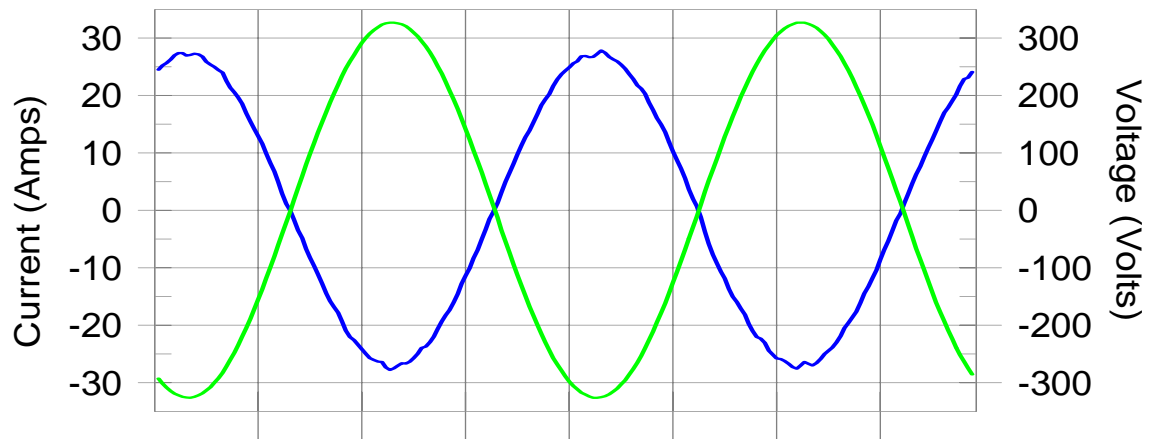

Harmonics and Class 3 limit line

European Limits

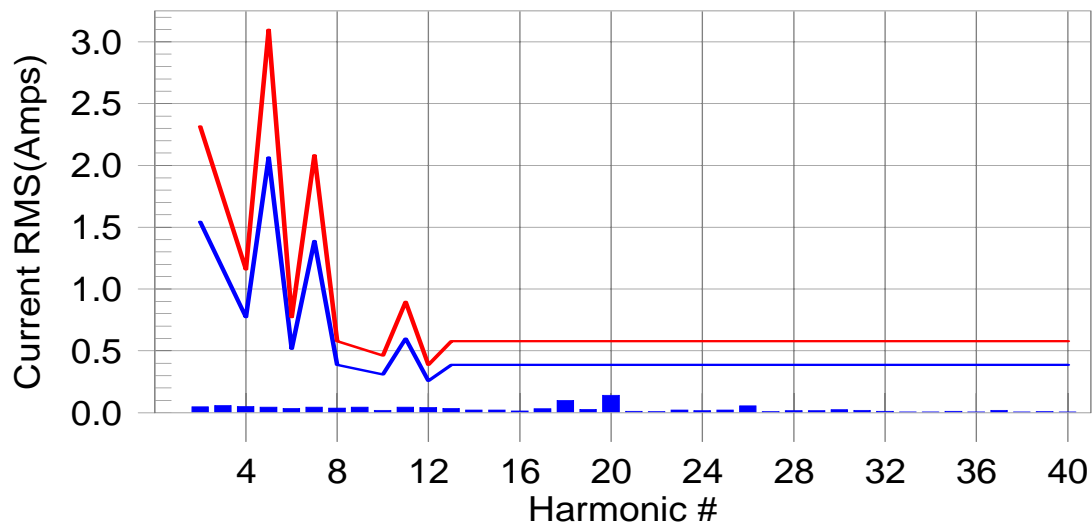

Test result: Pass

Worst harmonic was #12 with 16.33 % of the limit.

## TEST REPORT

### Current Test Result Summary (Phase A-Run time)

Highest parameter values during test:

V_RMS (Volts):	231.10	Frequency(Hz):	50.00
I_Peak (Amps):	28.238	I_RMS (Amps):	19.336
I_Fund (Amps):	19.297	Crest Factor:	1.462
Power (Watts):	-4466	Power Factor:	-1.000

Harm#	Harms(avg)	100%Limit	%of Limit	Harms(max)	150%Limit	%of Limit	Status
2	0.048	1.544	3.1	0.054	2.316	2.3	Pass
3	0.059	N/A	N/A	0.071	N/A	N/A	N/A
4	0.050	0.772	6.5	0.059	1.158	5.1	Pass
5	0.046	2.065	2.2	0.053	3.097	1.7	Pass
6	0.035	0.515	6.9	0.043	0.772	5.6	Pass
7	0.045	1.390	3.2	0.051	2.084	2.5	Pass
8	0.038	0.386	9.7	0.041	0.579	7.1	Pass
9	0.045	N/A	N/A	0.048	N/A	N/A	N/A
10	0.020	0.309	6.6	0.024	0.463	5.2	Pass
11	0.045	0.598	7.6	0.047	0.897	5.3	Pass
12	0.042	0.257	16.3	0.044	0.386	11.3	Pass
13	0.035	0.386	8.9	0.037	0.579	6.4	Pass
14	0.022	N/A	N/A	0.025	N/A	N/A	N/A
15	0.023	N/A	N/A	0.025	N/A	N/A	N/A
16	0.014	N/A	N/A	0.017	N/A	N/A	N/A
17	0.033	N/A	N/A	0.037	N/A	N/A	N/A
18	0.100	N/A	N/A	0.106	N/A	N/A	N/A
19	0.027	N/A	N/A	0.029	N/A	N/A	N/A
20	0.141	N/A	N/A	0.148	N/A	N/A	N/A
21	0.011	N/A	N/A	0.013	N/A	N/A	N/A
22	0.010	N/A	N/A	0.014	N/A	N/A	N/A
23	0.022	N/A	N/A	0.024	N/A	N/A	N/A
24	0.016	N/A	N/A	0.018	N/A	N/A	N/A
25	0.022	N/A	N/A	0.025	N/A	N/A	N/A
26	0.055	N/A	N/A	0.056	N/A	N/A	N/A
27	0.009	N/A	N/A	0.010	N/A	N/A	N/A
28	0.015	N/A	N/A	0.017	N/A	N/A	N/A
29	0.016	N/A	N/A	0.019	N/A	N/A	N/A
30	0.024	N/A	N/A	0.025	N/A	N/A	N/A
31	0.019	N/A	N/A	0.021	N/A	N/A	N/A
32	0.011	N/A	N/A	0.012	N/A	N/A	N/A
33	0.007	N/A	N/A	0.009	N/A	N/A	N/A
34	0.007	N/A	N/A	0.008	N/A	N/A	N/A
35	0.012	N/A	N/A	0.013	N/A	N/A	N/A
36	0.006	N/A	N/A	0.008	N/A	N/A	N/A
37	0.018	N/A	N/A	0.020	N/A	N/A	N/A
38	0.006	N/A	N/A	0.007	N/A	N/A	N/A
39	0.010	N/A	N/A	0.011	N/A	N/A	N/A
40	0.006	N/A	N/A	0.007	N/A	N/A	N/A

**TEST REPORT**

Harmonics – Per EN/IEC61000-3-12(Phase B-Run time)

Test Result: Pass      Source qualification: Normal

Current & voltage waveforms

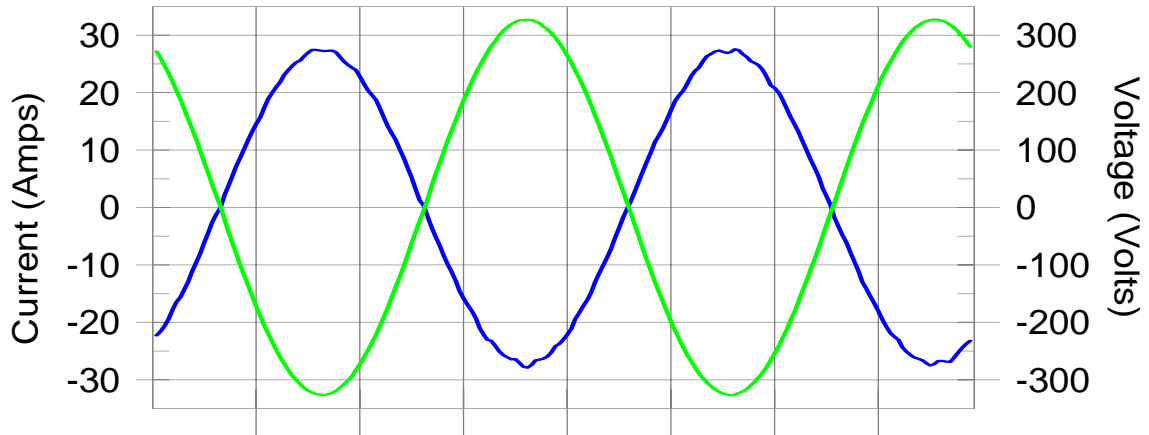

Harmonics and Class 3 limit line

European Limits

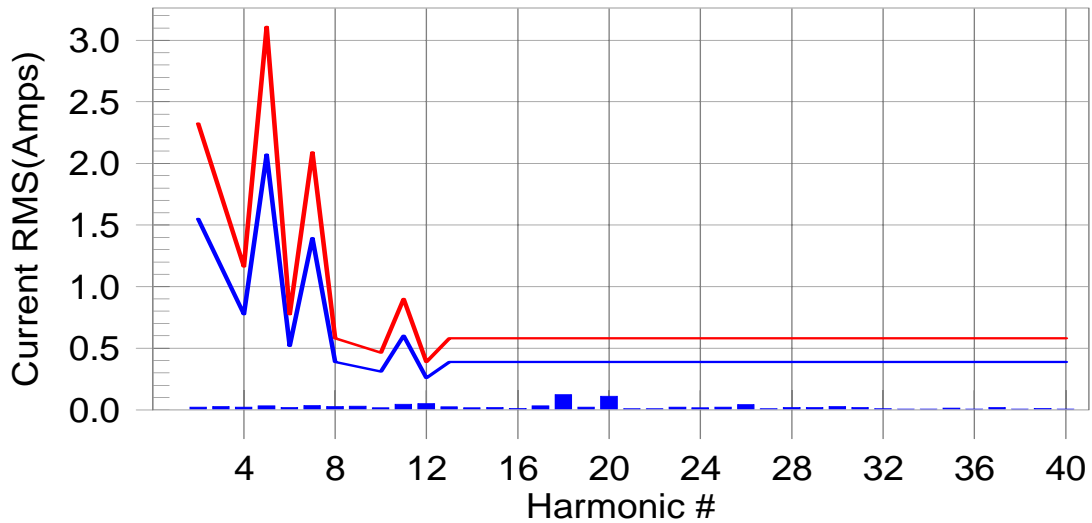

Test result: Pass      Worst harmonic was #12 with 20.56 % of the limit.

## TEST REPORT

### Current Test Result Summary (Phase B-Run time)

Test Result: Pass      Measured I-ref: 19.368 Amp rms      Source: Normal  
I-THC(%): 1.1    Limit(%): 13.0    PWHC(%): 4.4    PWHC Limit(%): 22.0

#### Highest parameter values during test:

V_RMS (Volts):	231.18	Frequency(Hz):	50.00
I_Peak (Amps):	28.512	I_RMS (Amps):	19.404
I_Fund (Amps):	19.368	Crest Factor:	1.470
Power (Watts):	-4482	Power Factor:	-1.000

Harm#	Harms(avg)	100%Limit	%of Limit	Harms(max)	150%Limit	%of Limit	Status
2	0.022	1.550	1.4	0.025	2.324	1.1	Pass
3	0.059	N/A	N/A	0.030	N/A	N/A	N/A
4	0.022	0.775	2.8	0.024	1.162	2.1	Pass
5	0.032	2.073	1.5	0.035	3.109	1.1	Pass
6	0.020	0.517	3.9	0.022	0.775	2.9	Pass
7	0.034	1.395	2.4	0.037	2.092	1.7	Pass
8	0.028	0.387	7.1	0.032	0.581	5.6	Pass
9	0.045	N/A	N/A	0.032	N/A	N/A	N/A
10	0.015	0.310	4.9	0.017	0.465	3.7	Pass
11	0.044	0.600	7.3	0.046	0.901	5.1	Pass
12	0.051	0.258	19.8	0.053	0.387	13.7	Pass
13	0.024	0.387	6.2	0.027	0.581	4.7	Pass
14	0.016	N/A	N/A	0.019	N/A	N/A	N/A
15	0.019	N/A	N/A	0.021	N/A	N/A	N/A
16	0.012	N/A	N/A	0.014	N/A	N/A	N/A
17	0.031	N/A	N/A	0.033	N/A	N/A	N/A
18	0.124	N/A	N/A	0.131	N/A	N/A	N/A
19	0.023	N/A	N/A	0.027	N/A	N/A	N/A
20	0.109	N/A	N/A	0.116	N/A	N/A	N/A
21	0.010	N/A	N/A	0.011	N/A	N/A	N/A
22	0.010	N/A	N/A	0.012	N/A	N/A	N/A
23	0.023	N/A	N/A	0.026	N/A	N/A	N/A
24	0.017	N/A	N/A	0.021	N/A	N/A	N/A
25	0.023	N/A	N/A	0.027	N/A	N/A	N/A
26	0.043	N/A	N/A	0.044	N/A	N/A	N/A
27	0.008	N/A	N/A	0.009	N/A	N/A	N/A
28	0.018	N/A	N/A	0.019	N/A	N/A	N/A
29	0.019	N/A	N/A	0.022	N/A	N/A	N/A
30	0.028	N/A	N/A	0.029	N/A	N/A	N/A
31	0.019	N/A	N/A	0.021	N/A	N/A	N/A
32	0.009	N/A	N/A	0.010	N/A	N/A	N/A
33	0.006	N/A	N/A	0.008	N/A	N/A	N/A
34	0.007	N/A	N/A	0.008	N/A	N/A	N/A
35	0.014	N/A	N/A	0.016	N/A	N/A	N/A
36	0.007	N/A	N/A	0.008	N/A	N/A	N/A
37	0.018	N/A	N/A	0.020	N/A	N/A	N/A
38	0.005	N/A	N/A	0.006	N/A	N/A	N/A
39	0.011	N/A	N/A	0.012	N/A	N/A	N/A
40	0.006	N/A	N/A	0.007	N/A	N/A	N/A

**TEST REPORT**

Harmonics – Per EN/IEC61000-3-12(Phase C-Run time)

Test Result: Pass      Source qualification: Normal

Current & voltage waveforms

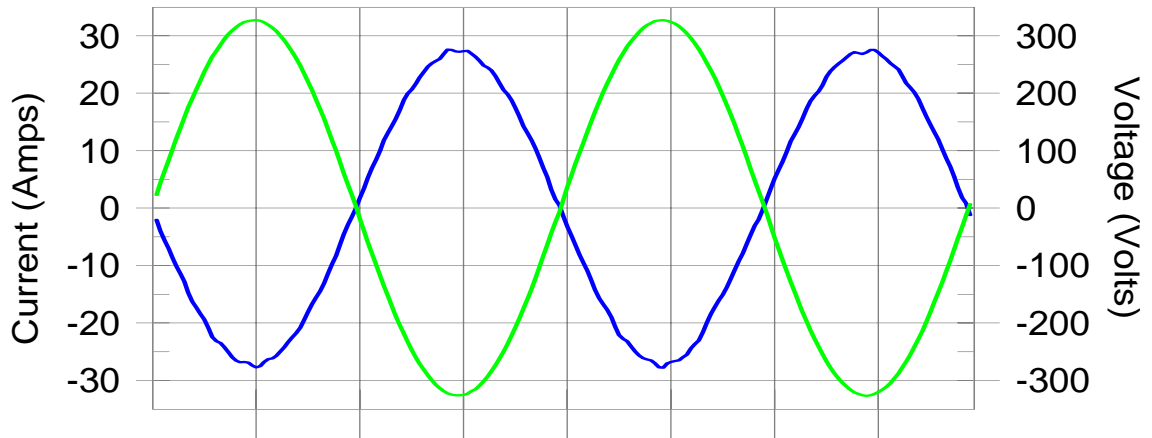

Harmonics and Class 3 limit line

European Limits

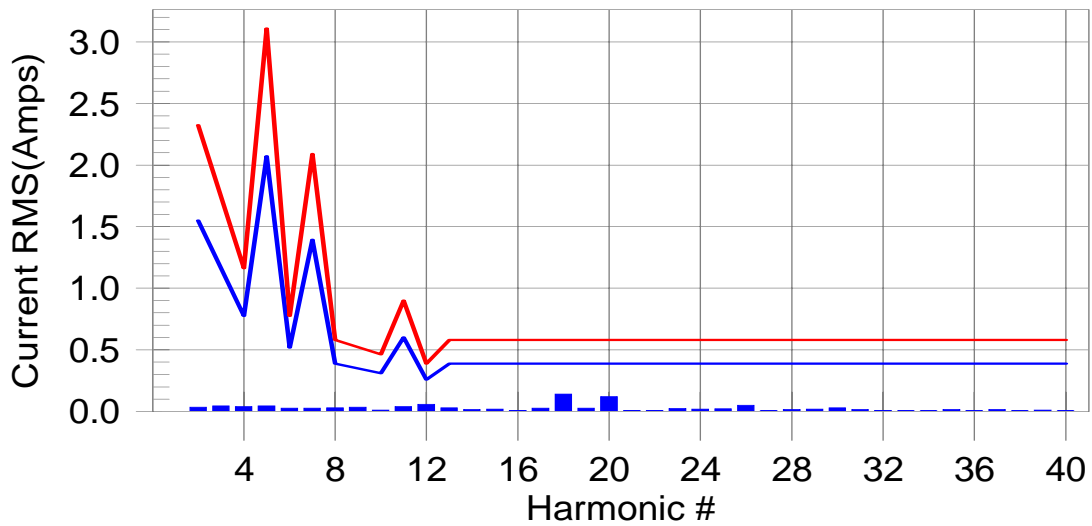

Test result: Pass

Worst harmonic was #12 with 23.14 % of the limit.

## TEST REPORT

### Current Test Result Summary (Phase C-Run time)

Test Result: Pass      Measured I-ref: 19.365 Amp rms      Source: Normal  
I-THC(%): 1.3    Limit(%): 13.0    PWHC(%): 4.8    PWHC Limit(%): 22.0

Highest parameter values during test:

V_RMS (Volts):	231.18	Frequency(Hz):	50.00
I_Peak (Amps):	28.371	I_RMS (Amps):	19.406
I_Fund (Amps):	19.365	Crest Factor:	1.463
Power (Watts):	-4484	Power Factor:	-1.000

Harm#	Harms(avg)	100%Limit	%of Limit	Harms(max)	150%Limit	%of Limit	Status
2	0.035	1.549	2.2	0.037	2.324	1.6	Pass
3	0.059	N/A	N/A	0.052	N/A	N/A	N/A
4	0.041	0.775	5.3	0.050	1.162	4.3	Pass
5	0.046	2.072	2.2	0.059	3.108	1.9	Pass
6	0.028	0.516	5.3	0.031	0.775	4.0	Pass
7	0.028	1.394	2.0	0.035	2.092	1.7	Pass
8	0.029	0.387	7.5	0.032	0.581	5.5	Pass
9	0.045	N/A	N/A	0.036	N/A	N/A	N/A
10	0.013	0.310	4.3	0.015	0.465	3.3	Pass
11	0.041	0.600	6.9	0.043	0.901	4.8	Pass
12	0.059	0.258	22.7	0.061	0.387	15.6	Pass
13	0.029	0.387	7.5	0.032	0.581	5.5	Pass
14	0.017	N/A	N/A	0.020	N/A	N/A	N/A
15	0.018	N/A	N/A	0.020	N/A	N/A	N/A
16	0.010	N/A	N/A	0.013	N/A	N/A	N/A
17	0.028	N/A	N/A	0.030	N/A	N/A	N/A
18	0.141	N/A	N/A	0.149	N/A	N/A	N/A
19	0.028	N/A	N/A	0.031	N/A	N/A	N/A
20	0.119	N/A	N/A	0.126	N/A	N/A	N/A
21	0.010	N/A	N/A	0.011	N/A	N/A	N/A
22	0.009	N/A	N/A	0.010	N/A	N/A	N/A
23	0.025	N/A	N/A	0.026	N/A	N/A	N/A
24	0.018	N/A	N/A	0.021	N/A	N/A	N/A
25	0.022	N/A	N/A	0.024	N/A	N/A	N/A
26	0.049	N/A	N/A	0.050	N/A	N/A	N/A
27	0.007	N/A	N/A	0.009	N/A	N/A	N/A
28	0.016	N/A	N/A	0.017	N/A	N/A	N/A
29	0.020	N/A	N/A	0.022	N/A	N/A	N/A
30	0.030	N/A	N/A	0.031	N/A	N/A	N/A
31	0.016	N/A	N/A	0.018	N/A	N/A	N/A
32	0.010	N/A	N/A	0.011	N/A	N/A	N/A
33	0.007	N/A	N/A	0.009	N/A	N/A	N/A
34	0.006	N/A	N/A	0.007	N/A	N/A	N/A
35	0.015	N/A	N/A	0.017	N/A	N/A	N/A
36	0.006	N/A	N/A	0.006	N/A	N/A	N/A
37	0.016	N/A	N/A	0.018	N/A	N/A	N/A
38	0.005	N/A	N/A	0.006	N/A	N/A	N/A
39	0.012	N/A	N/A	0.014	N/A	N/A	N/A
40	0.005	N/A	N/A	0.006	N/A	N/A	N/A

**TEST REPORT**

**Model: SOFAR 10000TL-G2**

Operation Mode: Inverting mode with full load

Harmonics – Class-A per Ed. 4.0 (2014)(Phase A-Run time) incl. inter-harmonics

Test Result: Pass      Source qualification: Normal

Current & voltage waveforms

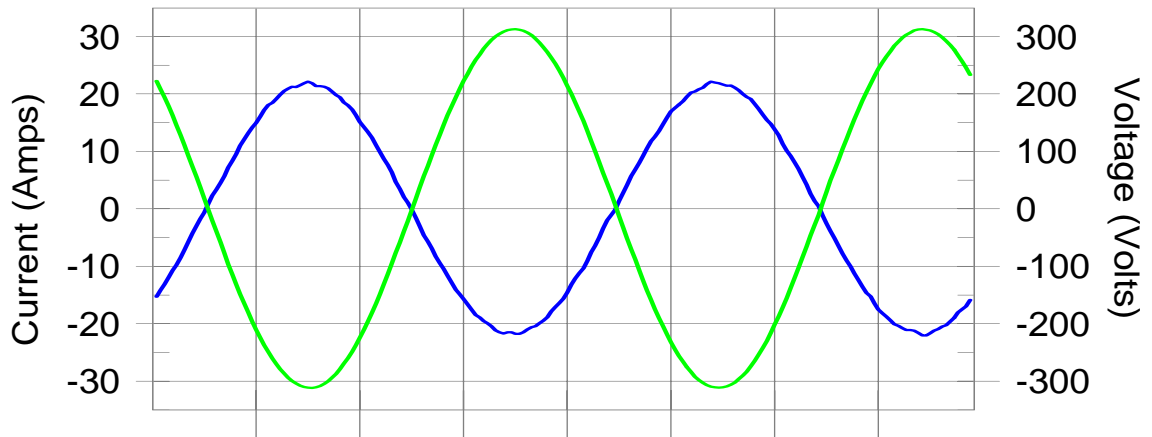

Harmonics and Class A limit line

European Limits

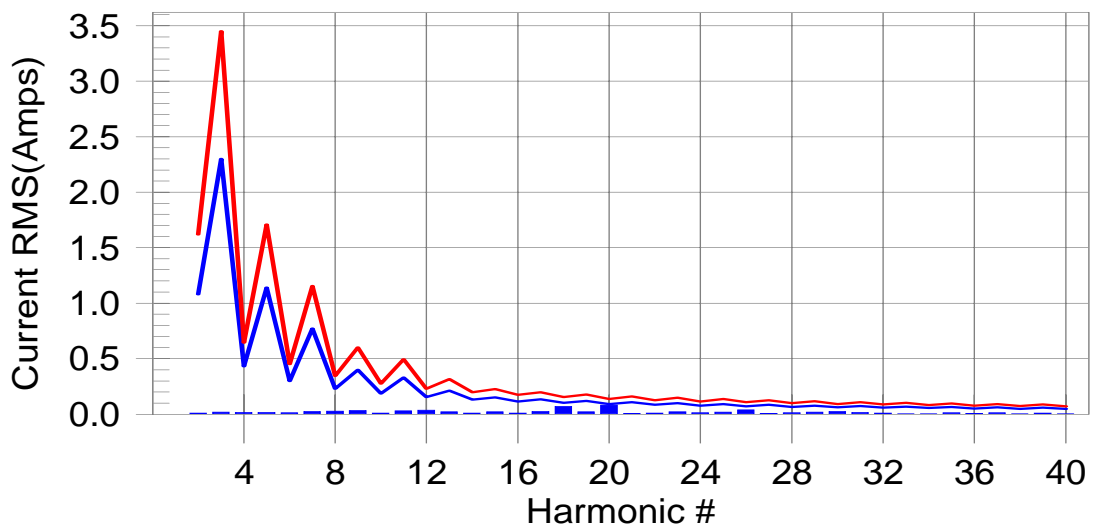

Test result: Pass      Worst harmonic was #20 with 89.5% of the limit.

## TEST REPORT

### Current Test Result Summary (Phase A-Run time)

Test Result: Pass      Source qualification: Normal  
 THC: 0.155 A    I-THD: 1.0 %    POHC(A): 0.041 A    POHC Limit(A): 0.251 A  
 Highest parameter values during test:  
     V\_RMS (Volts): 220.800      Frequency(Hz): 50.00  
     I\_Peak (Amps): 22.496      I\_RMS (Amps): 15.453  
     I\_Fund (Amps): 15.405      Crest Factor: 1.463  
     Power (Watts): -3398.9      Power Factor: -0.999

Harm#	Harms(avg)	100%Limit	%of Limit	Harms(max)	150%Limit	%of Limit	Status
2	0.010	1.080	0.9	0.013	1.620	0.8	Pass
3	0.017	2.300	0.7	0.026	3.450	0.8	Pass
4	0.016	0.430	3.7	0.019	0.645	2.9	Pass
5	0.016	1.140	1.4	0.017	1.710	1.0	Pass
6	0.014	0.300	4.5	0.017	0.450	3.8	Pass
7	0.025	0.770	3.2	0.027	1.155	2.3	Pass
8	0.027	0.230	11.8	0.030	0.345	8.6	Pass
9	0.032	0.400	7.9	0.033	0.600	5.6	Pass
10	0.011	0.184	6.1	0.015	0.276	5.4	Pass
11	0.030	0.330	9.0	0.031	0.495	6.3	Pass
12	0.036	0.153	23.7	0.038	0.230	16.8	Pass
13	0.021	0.210	10.1	0.022	0.315	7.1	Pass
14	0.011	0.131	8.1	0.013	0.197	6.6	Pass
15	0.022	0.150	14.5	0.023	0.225	10.2	Pass
16	0.011	0.115	9.5	0.014	0.173	8.2	Pass
17	0.025	0.132	19.0	0.027	0.198	13.6	Pass
18	0.069	0.102	67.3	0.070	0.153	45.5	Pass
19	0.021	0.118	17.7	0.023	0.178	12.9	Pass
20	0.082	0.092	89.5	0.083	0.138	60.4	Pass
21	0.007	0.107	N/A	0.008	0.161	N/A	Pass
22	0.009	0.084	N/A	0.011	0.125	N/A	Pass
23	0.020	0.098	20.5	0.022	0.147	14.8	Pass
24	0.012	0.077	16.0	0.014	0.115	12.3	Pass
25	0.019	0.090	21.4	0.021	0.135	15.6	Pass
26	0.040	0.071	56.0	0.041	0.107	38.3	Pass
27	0.006	0.083	N/A	0.007	0.125	N/A	Pass
28	0.014	0.066	21.8	0.015	0.099	15.3	Pass
29	0.017	0.078	21.8	0.018	0.116	15.7	Pass
30	0.024	0.061	39.0	0.025	0.092	26.7	Pass
31	0.015	0.073	21.0	0.016	0.109	14.6	Pass
32	0.009	0.058	16.2	0.010	0.086	11.7	Pass
33	0.005	0.068	N/A	0.006	0.102	N/A	Pass
34	0.005	0.054	N/A	0.006	0.081	N/A	Pass
35	0.012	0.064	19.4	0.014	0.096	14.4	Pass
36	0.007	0.051	N/A	0.008	0.077	N/A	Pass
37	0.014	0.061	22.4	0.015	0.091	16.1	Pass
38	0.004	0.048	N/A	0.005	0.073	N/A	Pass
39	0.009	0.058	16.3	0.010	0.087	12.0	Pass
40	0.005	0.046	N/A	0.006	0.069	N/A	Pass



**TEST REPORT**

Harmonics – Class-A per Ed. 4.0 (2014)(Phase B-Run time) incl. inter-harmonics

Test Result: Pass      Source qualification: Normal

Current & voltage waveforms

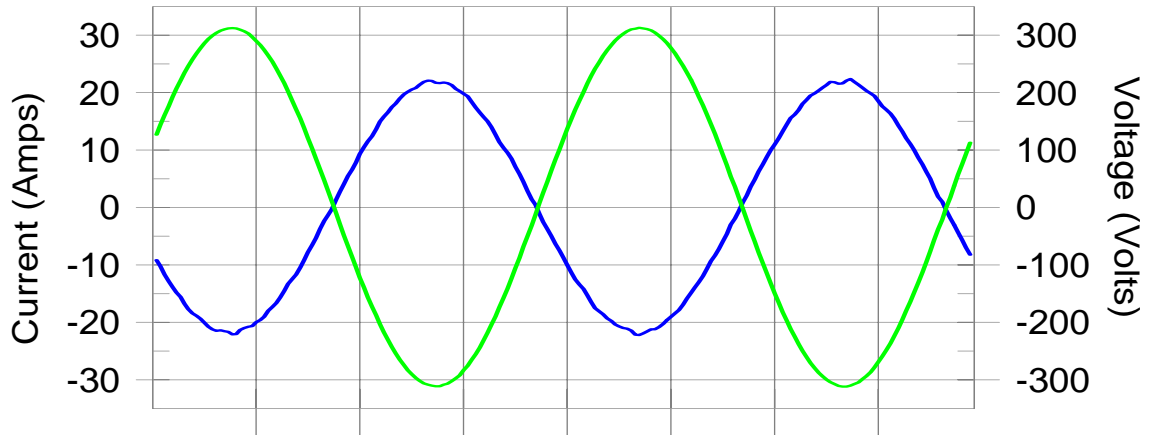

Harmonics and Class A limit line

European Limits

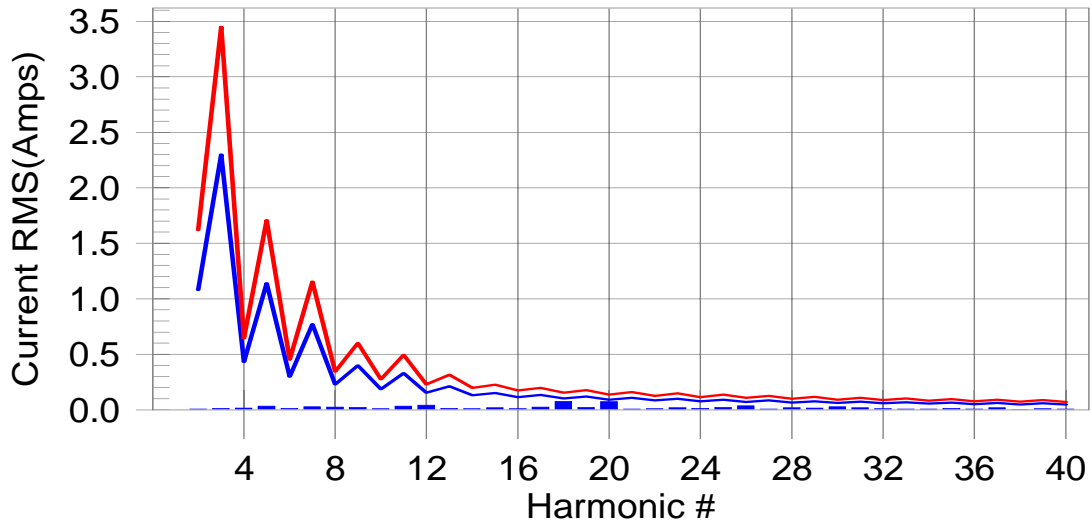

Test result: Pass      Worst harmonic was #20 with 78.0% of the limit.

## TEST REPORT

### Current Test Result Summary (Phase B-Run time)

Test Result: Pass      Source qualification: Normal  
 THC: 0.154 A    I-THD: 1.0 %    POHC(A): 0.045 A    POHC Limit(A): 0.251 A  
 Highest parameter values during test:  
     V\_RMS (Volts): 220.782                      Frequency(Hz): 50.00  
     I\_Peak (Amps): 22.646                      I\_RMS (Amps): 15.462  
     I\_Fund (Amps): 15.461                      Crest Factor: 1.467  
     Power (Watts): -3411.0                      Power Factor: -0.999

Harm#	Harms(avg)	100%Limit	%of Limit	Harms(max)	150%Limit	%of Limit	Status
2	0.008	1.080	N/A	0.010	1.620	N/A	Pass
3	0.013	2.300	0.6	0.018	3.450	0.5	Pass
4	0.016	0.430	3.7	0.019	0.645	2.9	Pass
5	0.031	1.140	2.7	0.033	1.710	1.9	Pass
6	0.014	0.300	4.5	0.016	0.450	3.7	Pass
7	0.028	0.770	3.6	0.030	1.155	2.6	Pass
8	0.024	0.230	10.3	0.025	0.345	7.4	Pass
9	0.023	0.400	5.6	0.024	0.600	4.1	Pass
10	0.011	0.184	6.2	0.014	0.276	5.2	Pass
11	0.032	0.330	9.6	0.034	0.495	6.9	Pass
12	0.041	0.153	26.5	0.043	0.230	18.5	Pass
13	0.014	0.210	6.7	0.016	0.315	5.1	Pass
14	0.011	0.131	8.2	0.013	0.197	6.6	Pass
15	0.019	0.150	12.5	0.021	0.225	9.4	Pass
16	0.011	0.115	9.7	0.014	0.173	7.9	Pass
17	0.023	0.132	17.7	0.026	0.198	13.3	Pass
18	0.076	0.102	74.7	0.077	0.153	50.4	Pass
19	0.021	0.118	17.4	0.024	0.178	13.4	Pass
20	0.072	0.092	78.0	0.073	0.138	52.8	Pass
21	0.008	0.107	N/A	0.009	0.161	N/A	Pass
22	0.010	0.084	11.7	0.011	0.125	8.7	Pass
23	0.018	0.098	18.6	0.020	0.147	13.8	Pass
24	0.012	0.077	15.6	0.014	0.115	11.9	Pass
25	0.022	0.090	24.7	0.024	0.135	17.8	Pass
26	0.035	0.071	49.7	0.036	0.107	34.1	Pass
27	0.006	0.083	N/A	0.007	0.125	N/A	Pass
28	0.018	0.066	26.5	0.018	0.099	18.5	Pass
29	0.016	0.078	20.8	0.017	0.116	14.5	Pass
30	0.026	0.061	42.7	0.027	0.092	29.4	Pass
31	0.018	0.073	24.7	0.019	0.109	17.8	Pass
32	0.009	0.058	N/A	0.009	0.086	N/A	Pass
33	0.005	0.068	N/A	0.006	0.102	N/A	Pass
34	0.006	0.054	N/A	0.007	0.081	N/A	Pass
35	0.013	0.064	20.4	0.014	0.096	14.8	Pass
36	0.008	0.051	N/A	0.009	0.077	N/A	Pass
37	0.017	0.061	27.9	0.018	0.091	20.0	Pass
38	0.005	0.048	N/A	0.006	0.073	N/A	Pass
39	0.011	0.058	18.3	0.011	0.087	13.2	Pass
40	0.006	0.046	N/A	0.007	0.069	N/A	Pass

**TEST REPORT**

Harmonics – Class-A per Ed. 4.0 (2014)(Phase C-Run time) incl. inter-harmonics

Test Result: Pass      Source qualification: Normal

Current & voltage waveforms

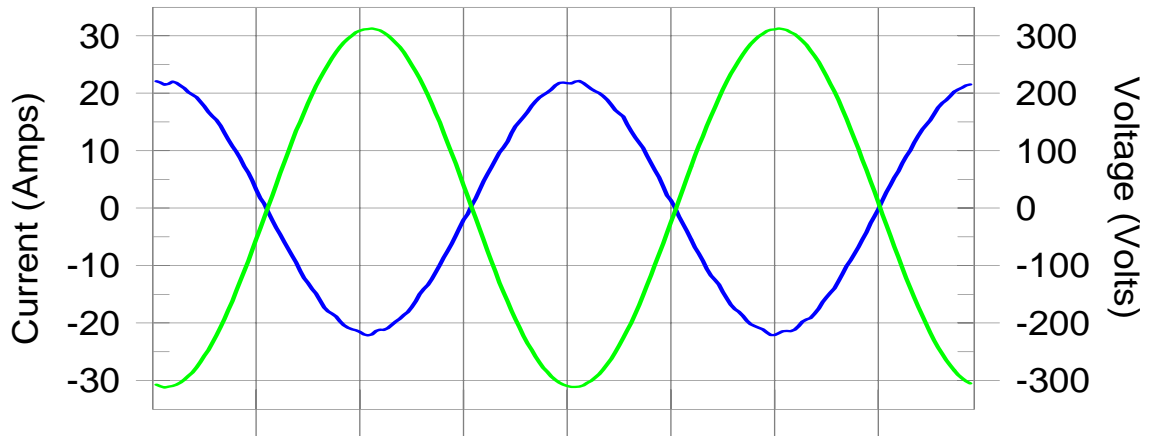

Harmonics and Class A limit line

European Limits

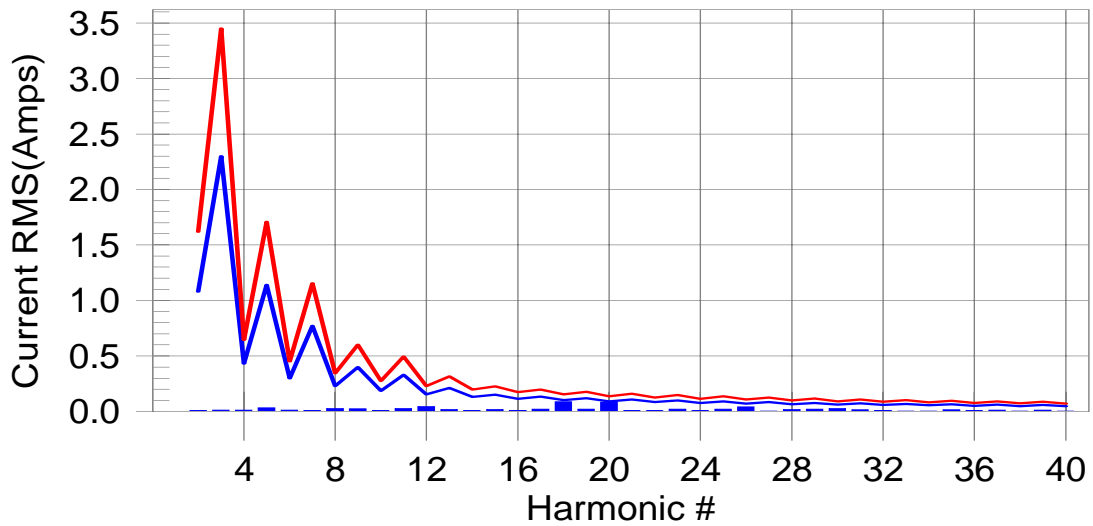

Test result: Pass      Worst harmonic was #20 with 90.7% of the limit.

## TEST REPORT

### Current Test Result Summary (Phase C-Run time)

Test Result: Pass      Source qualification: Normal  
 THC: 0.165 A    I-THD: 1.1 %    POHC(A): 0.045 A    POHC Limit(A): 0.251 A  
 Highest parameter values during test:  
     V\_RMS (Volts): 220.790                      Frequency(Hz): 50.00  
     I\_Peak (Amps): 22.557                      I\_RMS (Amps): 15.460  
     I\_Fund (Amps): 15.459                      Crest Factor: 1.462  
     Power (Watts): -3411.2                      Power Factor: -1.000

Harm#	Harms(avg)	100%Limit	%of Limit	Harms(max)	150%Limit	%of Limit	Status
2	0.009	1.080	N/A	0.013	1.620	N/A	Pass
3	0.013	2.300	0.6	0.016	3.450	0.5	Pass
4	0.013	0.430	3.1	0.016	0.645	2.4	Pass
5	0.031	1.140	2.7	0.033	1.710	1.9	Pass
6	0.014	0.300	4.6	0.016	0.450	3.5	Pass
7	0.010	0.770	1.3	0.015	1.155	1.3	Pass
8	0.026	0.230	11.4	0.028	0.345	8.2	Pass
9	0.024	0.400	6.1	0.027	0.600	4.5	Pass
10	0.009	0.184	N/A	0.011	0.276	N/A	Pass
11	0.027	0.330	8.3	0.029	0.495	5.9	Pass
12	0.045	0.153	29.4	0.047	0.230	20.5	Pass
13	0.016	0.210	7.7	0.017	0.315	5.5	Pass
14	0.009	0.131	7.2	0.011	0.197	5.7	Pass
15	0.016	0.150	10.7	0.019	0.225	8.3	Pass
16	0.008	0.115	N/A	0.010	0.173	N/A	Pass
17	0.021	0.132	15.8	0.023	0.198	11.5	Pass
18	0.087	0.102	85.0	0.090	0.153	59.0	Pass
19	0.022	0.118	18.9	0.025	0.178	13.8	Pass
20	0.083	0.092	90.7	0.084	0.138	61.2	Pass
21	0.008	0.107	N/A	0.009	0.161	N/A	Pass
22	0.008	0.084	N/A	0.009	0.125	N/A	Pass
23	0.022	0.098	22.3	0.023	0.147	15.6	Pass
24	0.006	0.077	N/A	0.007	0.115	N/A	Pass
25	0.020	0.090	22.0	0.021	0.135	15.5	Pass
26	0.041	0.071	58.2	0.042	0.107	39.7	Pass
27	0.005	0.083	N/A	0.006	0.125	N/A	Pass
28	0.016	0.066	24.1	0.017	0.099	16.9	Pass
29	0.020	0.078	25.8	0.022	0.116	18.6	Pass
30	0.027	0.061	44.7	0.029	0.092	31.1	Pass
31	0.015	0.073	20.4	0.015	0.109	14.2	Pass
32	0.010	0.058	17.0	0.010	0.086	12.1	Pass
33	0.004	0.068	N/A	0.005	0.102	N/A	Pass
34	0.005	0.054	N/A	0.005	0.081	N/A	Pass
35	0.015	0.064	22.7	0.016	0.096	16.8	Pass
36	0.007	0.051	N/A	0.008	0.077	N/A	Pass
37	0.014	0.061	23.7	0.015	0.091	16.8	Pass
38	0.005	0.048	N/A	0.007	0.073	N/A	Pass
39	0.012	0.058	20.6	0.013	0.087	14.8	Pass
40	0.005	0.046	N/A	0.006	0.069	N/A	Pass

## TEST REPORT

### 7. Flicker

Test Result: Pass

#### 7.1 Block Diagram of Test Setup

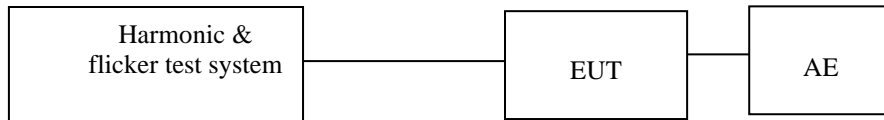

#### 7.2 Test Setup and Procedure

##### 7.2.1 Definition

Flicker:	impression of unsteadiness of visual sensation induced by a lighting stimulus whose luminance or spectral distribution fluctuates with time.
Pst:	Short-term flicker indicator The flicker severity evaluated over a short period (in minutes); Pst=1 is the conventional threshold of irritability
Plt:	long-term flicker indicator; the flicker severity evaluated over a long period (a few hours). Using successive Pst value.
dc:	the relative steady-state voltage change
dmax:	the maximum relative voltage change
d(t):	the value during a voltage change

##### 7.2.2 Test condition

The EUT was set to produce the most unfavourable sequence of voltage changes.

## TEST REPORT

### 7.3 Test Data

#### Model: SOFAR 15000TL-G2

Flicker Test Summary (Phase A-Run time) per EN/IEC61000-3-11

Z-test Phase = (0.150 + j 0.150 Ohm) Neutral = (0.100 + j 0.100 Ohm)

Test Result: Pass

Status: Test Completed

Parameter values recorded during the test:

Vrms at the end of test (Volt): 236.00

T-max (mS):	0.0	Test limit (mS):	500.0	Pass
Highest dc (%):	0.00	Test limit (%):	3.30	Pass
Highest dmax (%):	-0.12	Test limit (%):	4.00	Pass
Highest Pst (10 min. period):	0.152	Test limit:	1.000	Pass
Highest Plt (2 hr. period):	0.067	Test limit:	0.650	Pass

Calculated dmax(%): 0.000

Calculated dc(%): 0.000

Calculated Pst : 0.203

Calculated Plt : 0.089

**TEST REPORT**

Flicker Test Summary (Phase B-Run time) per EN/IEC61000-3-11

Z-test Phase = (0.150 + j 0.150 Ohm) Neutral = (0.100 + j 0.100 Ohm)

Test Result: Pass  
Status: Test Completed

Parameter values recorded during the test:

Vrms at the end of test (Volt): 236.07

Time(mS) > dt:	0.0	Test limit (mS):	500.0	Pass
Highest dc (%):	0.00	Test limit (%):	3.30	Pass
Highest dmax (%):	-0.17	Test limit (%):	4.00	Pass
Highest Pst (10 min. period):	0.328	Test limit:	1.000	Pass
Highest Plt (2 hr. period):	0.143	Test limit:	0.650	Pass

Calculated dmax(%): 0.000  
Calculated dc(%): 0.000  
Calculated Pst : 0.438  
Calculated Plt : 0.191

**TEST REPORT**

Flicker Test Summary (Phase C-Run time) per EN/IEC61000-3-11

Z-test Phase = (0.150 + j 0.150 Ohm) Neutral = (0.100 + j 0.100 Ohm)

Test Result: Pass  
Status: Test Completed

Parameter values recorded during the test:

Vrms at the end of test (Volt): 236.41

Time(mS) > dt:	0.0	Test limit (mS):	500.0	Pass
Highest dc (%):	0.00	Test limit (%):	3.30	Pass
Highest dmax (%):	-0.15	Test limit (%):	4.00	Pass
Highest Pst (10 min. period):	0.275	Test limit:	1.000	Pass
Highest Plt (2 hr. period):	0.120	Test limit:	0.650	Pass

Calculated dmax(%): 0.000  
Calculated dc(%): 0.000  
Calculated Pst : 0.368  
Calculated Plt : 0.161



## TEST REPORT

### Model: SOFAR 10000TL-G2

Flicker Test Summary per EN/IEC61000-3-3 (Phase A-Run time)

Test Result: Pass

Status: Test Completed

Parameter values recorded during the test:

Vrms at the end of test (Volt):	234.16			
Highest dt (%):	0.00	Test limit (%):	N/A	N/A
T-max (mS):	0.0	Test limit (mS):	500.0	Pass
Highest dc (%):	0.00	Test limit (%):	3.30	Pass
Highest dmax (%):	-0.14	Test limit (%):	4.00	Pass
Highest Pst (10 min. period):	0.152	Test limit:	1.000	Pass
Highest Plt (2 hr. period):	0.067	Test limit:	0.650	Pass

Flicker Test Summary per EN/IEC61000-3-3 (Phase B-Run time)

Test Result: Pass

Status: Test Completed

Parameter values recorded during the test:

Vrms at the end of test (Volt):	234.14			
Highest dt (%):	0.00	Test limit (%):	N/A	N/A
Tmax(mS) > dt:	0.0	Test limit (mS):	500.0	Pass
Highest dc (%):	0.00	Test limit (%):	3.30	Pass
Highest dmax (%):	-0.17	Test limit (%):	4.00	Pass
Highest Pst (10 min. period):	0.328	Test limit:	1.000	Pass
Highest Plt (2 hr. period):	0.143	Test limit:	0.650	Pass

Flicker Test Summary per EN/IEC61000-3-3 (Phase C-Run time)

Test Result: Pass

Status: Test Completed

Parameter values recorded during the test:

Vrms at the end of test (Volt):	234.38			
Highest dt (%):	0.00	Test limit (%):	N/A	N/A
Tmax(mS) > dt:	0.0	Test limit (mS):	500.0	Pass
Highest dc (%):	0.00	Test limit (%):	3.30	Pass
Highest dmax (%):	0.20	Test limit (%):	4.00	Pass
Highest Pst (10 min. period):	0.283	Test limit:	1.000	Pass
Highest Plt (2 hr. period):	0.124	Test limit:	0.650	Pass

**TEST REPORT**

**8. EMS TEST**

**Performance Criteria:**

- Criterion A: The apparatus shall continue to operate as intended during the test. No degradation of performance or loss of function is allowed below a performance level (or permission loss of performance) specified by the manufacturer, when the apparatus is used as intended. If the minimum performance level or the permissible performance loss is not specified by the manufacturer, then either of these may be derived from the product description and documentation and from what the user may reasonably expect from the apparatus if used as intended.
- Criterion B: The apparatus shall continue to operate as intended after the test. No degradation of performance or loss of function is allowed below a performance level (or permission loss of performance) specified by the manufacturer, when the apparatus is used as intended. During the test, degradation of performance is allowed, however, no change of actual operating state or stored data is allowed. If the minimum performance level or the permissible performance loss is not specified by the manufacturer, then either of these may be derived from the product description, and documentation, and from what the user may reasonably expect from the apparatus if used as intended.
- Criterion C: Temporary loss of function is allowed, provided the function is self-recoverable or can be restored by the operation of the controls, or by any operation specified in the instruction for use.

**Operation mode of EMS test:**

Test Item	Operation mode
ESD immunity	Inverting mode with lighting load
Radiated EM field immunity	
EFT immunity	
Surge immunity	
Inject current immunity	
Power frequency magnetic field immunity	
Voltage dips and interruption immunity	

*Note: "N/A" means Not Applicable in below text.*

**8.1 EN 61000-4-2(Pursuant to EN 61000-6-1) Electrostatic Discharge Immunity**

Performance criterion: B

Test Result: Pass

## TEST REPORT

### 8.1.1 Block Diagram of Test Setup

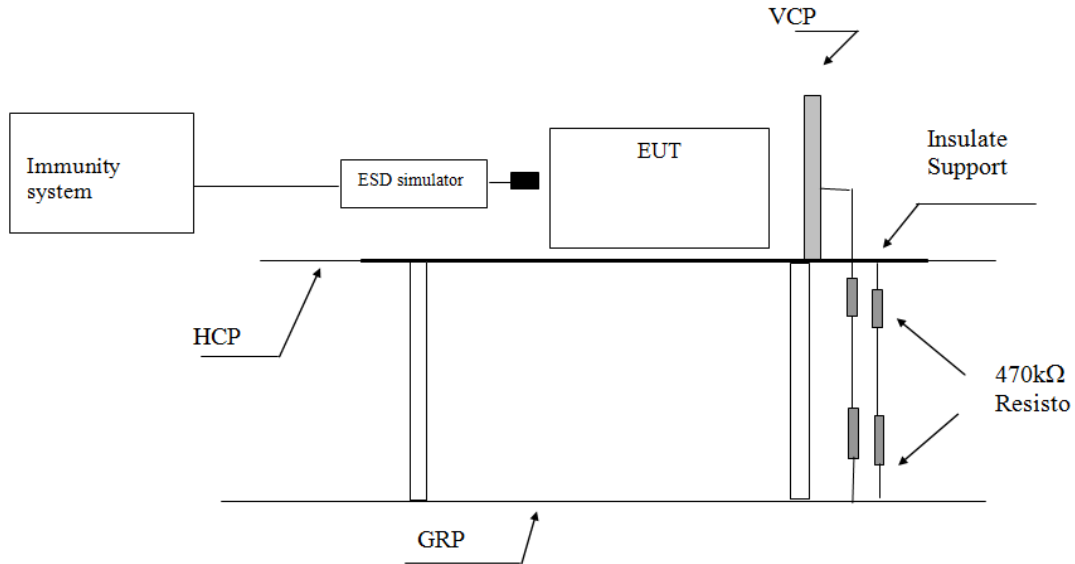

Note: HCP means Horizontal Coupling Plane,

VCP means Vertical Coupling Plane

GRP means Ground Reference Plane

### 8.1.2 Test Setup and Procedure

The EUT was put on a 0.8m high wooden table 0.1m high for floor standing equipment standing on the ground reference plane (GRP) 3m by 2m in size, made by iron 1.0 mm thick.

A horizontal coupling plane(HCP) 1.6m by 0.8m in size was placed on the table, and the EUT with its cables were isolated from the HCP by an insulating support thick than 0.5mm. The VCP 0.5m by 0.5m in size & HCP were constructed from the same material type & thickness as that of the GRP, and connected to the GRP via a 470kΩ resistor at each end.

The distance between EUT and any of the other metallic surface excepted the GRP, HCP & VCP was greater than 1m.

The EUT was arranged and connected according to its functional requirements.

Direct static electricity discharges were applied only to those points and surface which were accessible to personnel during normal usage.

## TEST REPORT

On each preselected points 10 times of each polarity single discharge were applied. The time interval between successive single discharges was at least 1s.

The ESD generator was held perpendicular to the surface to which the discharge was applied. The discharge return cable of the generator was kept at a distance of 0.2m whilst the discharge was being applied. During the contact discharges, the tip of the discharge electrode was touched the EUT before the discharge switch was operated. During the air discharges, the round discharge tip of the discharge electrode was approached as fast as possible to touch the EUT.

Indirect discharge was conducted to objects placed near the EUT, simulated by applying the discharges of the ESD generator to a coupling plane, in the contact discharge mode.

After each discharge, the ESD generator was removed from the EUT, the generator was then retriggered for a new single discharge. For ungrounded product, a grounded carbon fibre brush with bleeder resistors (2x470 kΩ) in the grounding cable was used after each discharge to remove remnant electrostatic voltage.

For air discharge, a minimum of 10 single air discharges were applied to the selected test point for each such area.

### 8.1.3 Test Result

<b>Direct Application of ESD</b>
----------------------------------

#### Direct Contact Discharge

Applied Voltage (kV)	No. of Discharge for each point	Result	Discharged Points
4	20	Pass	Accessible metal parts of the EUT Conductive substrate with coating which is not declared to be insulating

#### Direct Air Discharge

Applied Voltage (kV)	No. of Discharge for each point	Result	Discharged Points
2, 4, 8	20	Pass	All accessible points where contact discharge cannot be applied such as Displays, Indicators light, Keyboard, Button, Switch, Knob, Air gap, Slots, Hole and so on

**TEST REPORT**

**Indirect Application of ESD**

Horizontal Coupling Plane under the EUT

Applied Voltage (kV)	No. of Discharge for each point	Result	Discharged Point
4	20	Pass	At the front edge of each HCP opposite the centre point of each unit of the EUT

Vertical Coupling Plane beside the EUT

Applied Voltage (kV)	No. of Discharge for each point	Result	Discharged Point
4	20	Pass	The centre of the vertical edge of the coupling plane

**8.2 EN 61000-4-6(Pursuant to EN 61000-6-1) Injected Current (0.15 MHz to 80 MHz)**

Tested Port:  AC power     DC power     Functional earth     Signal/Control

Performance criterion: A

Test Result: Pass

**8.2.1 Block Diagram of Test Setup**

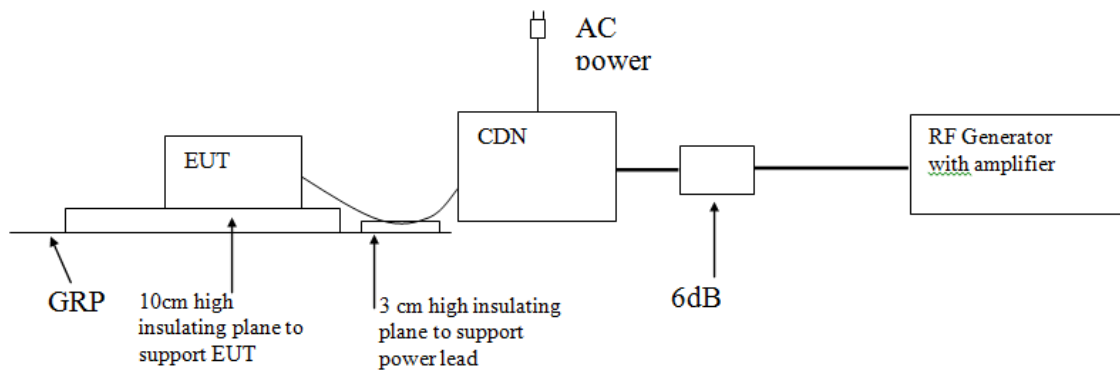

**8.2.2 Test Setup and Procedure**

The EUT was placed on an insulating support of 0.1m height above a ground reference Plane, arranged and connected to satisfy its functional requirement.

All relevant cables were provided with the appropriate coupling and decoupling devices at a distance between 0.1m and 0.3m from the projected geometry of the EUT on an insulating support of 0.03m height above the ground reference plane.

Test voltage was verified before each testing though power meter combined in the RF generator with AMP.

## TEST REPORT

Dwell time was set to 3s and step was set as 1% to keep sufficient response time for EUT. The frequency from 0.15MHz to 80MHz was checked.

The frequency range is scanned as specified. However, when specified in Annex A of EN 61000-6-1, an additional comprehensive functional test shall be carried out at a limited number of frequencies. The selected frequencies for conducted test are: 0,2; 1; 7,1; 13,56; 21; 27,12 and 40,68 MHz ( $\pm 1\%$ ).

### 8.2.3 Test Result

Port	Frequency (MHz)	Level	Result
A.C. Power Lines	0.15 to 80	3V (r.m.s.)	Pass
D.C. Power Lines	0.15 to 80	3V (r.m.s.)	Pass
Signal Lines	0.15 to 80	3V (r.m.s.)	Pass
Control Lines	0.15 to 80	3V (r.m.s.)	Pass
Functional Earth	0.15 to 80	3V (r.m.s.)	N/A

### 8.3 EN 61000-4-4(Pursuant to EN 61000-6-1) Electrical Fast Transient/Burst

Tested Port:  AC power     DC power     Functional earth     Signal/Control

Performance criterion: B

Test Result: Pass

#### 8.3.1 Block Diagram of Test Setup

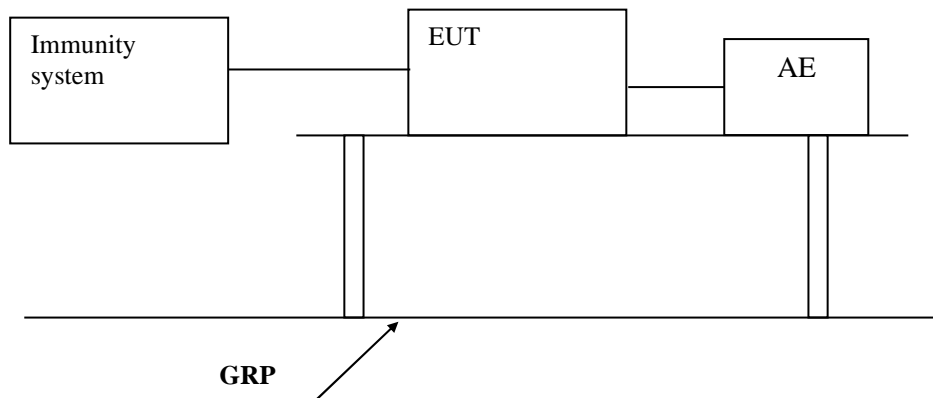

#### 8.3.2 Test Setup and Procedure

The EUT was placed on a 0.1m high wooden table, standing on the ground reference plane 3m by 2m in size, made by steel 1mm thick.

The distance between the EUT and any other of the metallic surface except the GRP was greater than 0.5m.

**TEST REPORT**

The mains lead excess than 0.5m was folded to avoid a flat coil and situated at a distance of 0.1m above the ground reference plane to insure the distance between the coupling device and the EUT was 0.5m.

The EUT was arranged and connected to satisfy its functional requirement and supplied by the coupling-decoupling network. Repetition Frequency was 5 kHz.

**8.3.3 Test Result**

Level	Polarity	A.C. Power supply line and functional earth terminal	D.C. Power Lines, Signal Line & Control Line
0.5 kV	+	N/A	Pass
0.5 kV	-	N/A	Pass
1 kV	+	Pass	N/A
1 kV	-	Pass	N/A

**8.4 EN 61000-4-5(Pursuant to EN 61000-6-1) Surge Immunity**

Tested Port:  AC power     DC power

Performance criterion: B

Test Result: Pass

**8.4.1 Block Diagram of Test Setup**

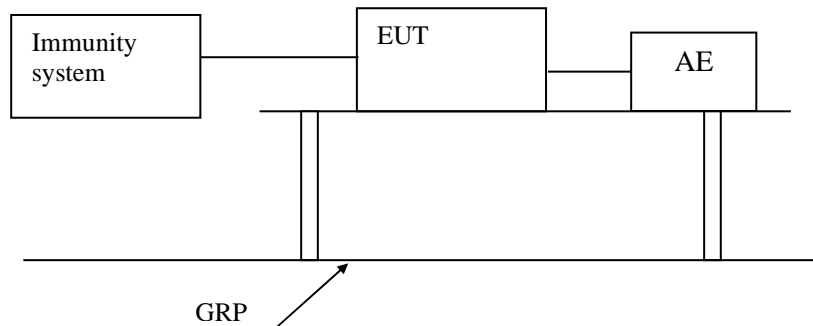

**8.4.2 Test Setup and Procedure**

The surge was applied to the EUT power supply terminals via the capacitive coupling network.

Decoupling networks were required in order to avoid possible adverse effects on equipment not under test that might be powered by the same lines and to provide sufficient decoupling impedance to the surge wave so that the specified wave might be developed on the lines under test.

The EUT was arranged and connected according to its functional requirements.

**TEST REPORT**

The EUT was placed on a 0.1m high wooden support above the GRP), supplied by the coupling-decoupling network, and arranged and connected to satisfy its functional requirement. The power cord between the EUT and the coupling/decoupling network was less than 2 meters.

**8.4.3 Test Result**

Tested Port	Level	Result
AC power	Line to line $\pm 0.5\text{kV}$ , $\pm 1\text{kV}$	Pass
AC power	Line to earth $\pm 0.5\text{kV}$ , $\pm 1\text{kV}$ , $\pm 2\text{kV}$	Pass
DC power	Line to earth $\pm 0.5\text{kV}$	N/A

**8.5 EN 61000-4-11(Pursuant to EN 61000-6-1) Voltage Dips and Interruptions**

Tested Port: AC power

Test Result: Not Applicable

Remark: the test only applicable to the AC input port.



## TEST REPORT

### 8.6 EN 61000-4-3(Pursuant to EN 61000-6-1) Radiated Electromagnetic Field Immunity

Performance criterion: A

Test Result: Pass

#### 8.6.1 Block Diagram of Test Setup

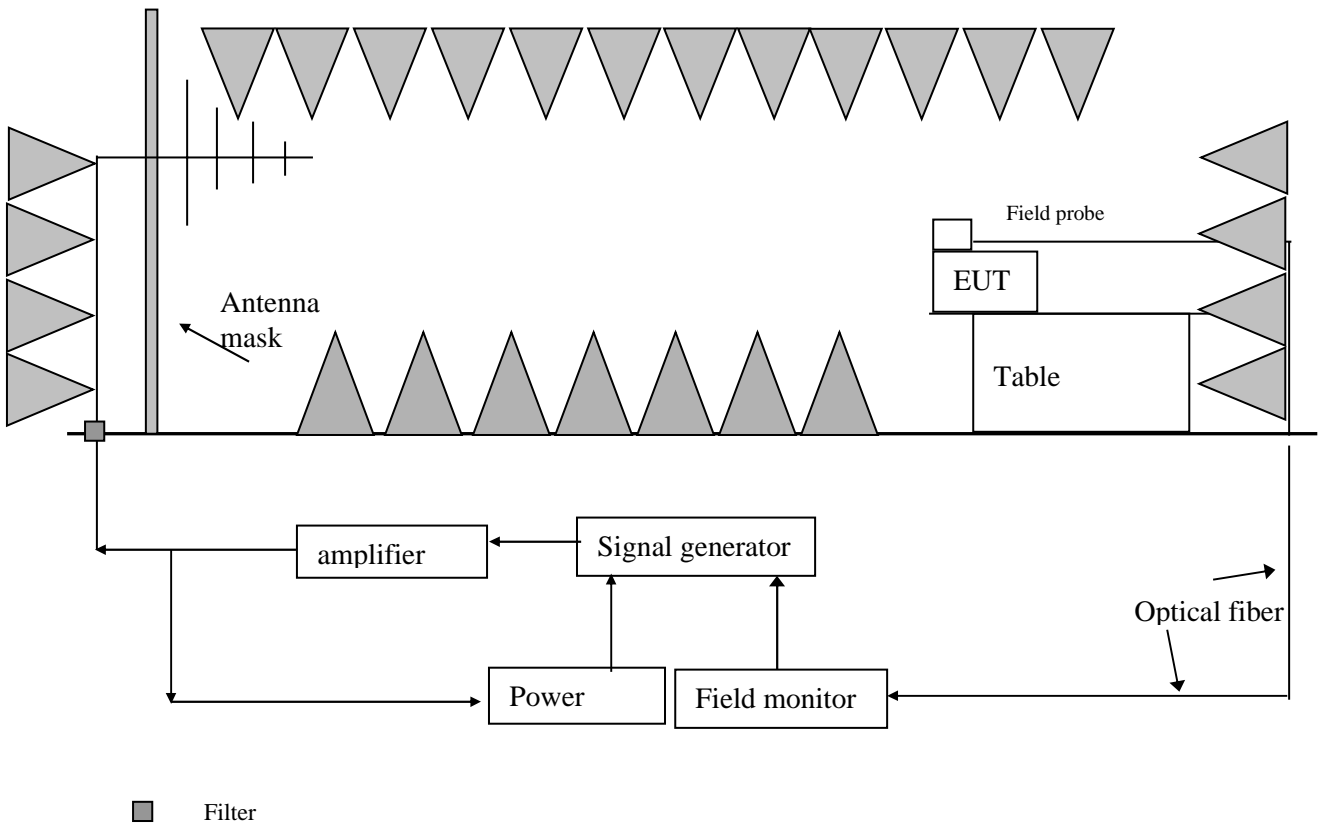

## TEST REPORT

### 8.6.2 Test Setup and Procedure

The test was conducted in a fully anechoic chamber to maintain a uniform field of sufficient dimensions with respect to the EUT, and also in order to comply with various national and international laws prohibiting interference to radio communications.

The equipment was placed in the test facility on a non-conducting table 0.8m high (for floor standing EUT, is placed on a non-conducting support 0.1m height).

The EUT was placed on the uniform calibrated plane which is 3V/m and 1V/m EM field.

For all ports connected to EUT, manufacturer specified cable type and length was used, for those cables no specification, unshielded cable applied. Wire was left exposed to the electromagnetic field for a distance of 1 m from the EUT.

The EUT was arranged and connected according to its functional requirements

Before testing, the intensity of the established field strength had been checked by placing the field sensor at a calibration grid point, and with the field generating antenna and cables in the same positions as used for the calibration, the forward power needed to give the calibrated field strength was measured. Spot checks was made at a number of calibration grid points over the frequency range 80 to 1000 MHz and 1.4 to 2.7 GHz, both polarizations was checked. After calibration, the EUT was initially placed with one face coincident with the calibration plane.

The frequency range was swept from 80 to 1000MHz and 1.4 to 2.7 GH, with the signal 80% amplitude modulated with a 1 kHz sinewave, pausing to adjust the r.f. signal level. The dwell time at each frequency was 3s so as that the EUT to be exercised and be able to respond.

The step size was 1% of the fundamental with linear interpolation between calibrated points. Test was performed with the generating antenna facing each of the four sides of the EUT.

### 8.6.3 Test Result

Frequency (MHz)	Exposed Side	Field Strength (V/m)	Result
80 to 1000	Front	3 V/m (r.m.s.)	Pass
80 to 1000	Left	3 V/m (r.m.s.)	Pass
80 to 1000	Rear	3 V/m (r.m.s.)	Pass
80 to 1000	Right	3 V/m (r.m.s.)	Pass

Frequency	Exposed Side	Field Strength	Result
-----------	--------------	----------------	--------

**TEST REPORT**

(MHz)		(V/m)	
1.4 to 2.0	Front	3 V/m (r.m.s.)	Pass
1.4 to 2.0	Left	3 V/m (r.m.s.)	Pass
1.4 to 2.0	Rear	3 V/m (r.m.s.)	Pass
1.4 to 2.0	Right	3 V/m (r.m.s.)	Pass

Frequency (MHz)	Exposed Side	Field Strength (V/m)	Result
2.0 to 2.7	Front	1 V/m (r.m.s.)	Pass
2.0 to 2.7	Left	1 V/m (r.m.s.)	Pass
2.0 to 2.7	Rear	1 V/m (r.m.s.)	Pass
2.0 to 2.7	Right	1 V/m (r.m.s.)	Pass

## TEST REPORT

### 8.7 EN 61000-4-8(Pursuant to EN 61000-6-1) Power Frequency Magnetic Field Immunity

Tested Port: Enclosure

Performance criterion: A

#### 8.7.1 Block Diagram of Test Setup

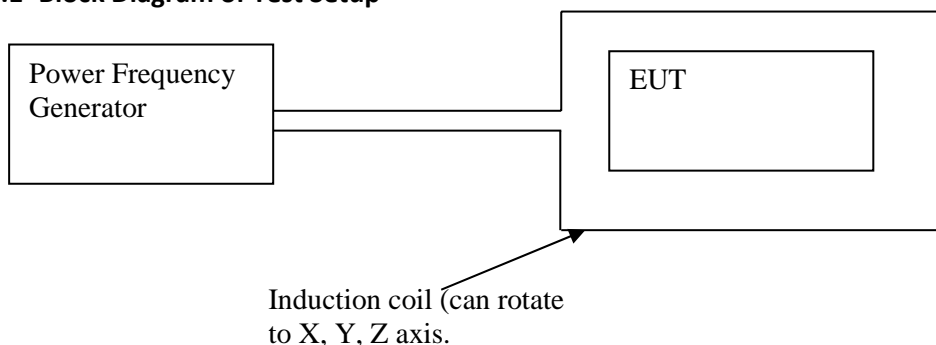

#### 8.7.2 Test Setup and Procedure

Put EUT into center of induction coil (with suitable dimensions) in the testing.

For tabletop equipment:

The EUT was placed on a big enough wooden desk with height of 0.8m and operating as intended.

The equipment shall be subjected to the test magnetic field by using the induction coil of standards (1m\*1m).

The induction coil shall be rotated by 90° in order to expose the EUT to the test field with different orientations.

For Floor-standing equipment:

The EUT was placed on big enough wooden desk with height of 0.1m and operating as intended.

The equipment shall be subjected to the test magnetic field by using induction coils of suitable dimensions; the test shall be repeated by moving and shifting the induction coils, in order to test the whole volume of the EUT for each orthogonal direction. The test shall be repeated with the coil shifted to different position along the side of the EUT, in steps corresponding to 50% of the shortest side of the coil.

The induction coil shall then be rotated by 90° in order to expose the EUT to the test field with different orientations and the same procedure followed.

#### 8.7.3 Test Result

**TEST REPORT**

Mains frequency:  50 Hz                       60 Hz

Orientations of induction coil	Magnetic Field Strength (A/m)	Result
X	3 A/m	Pass
Y	3 A/m	Pass
Z	3 A/m	Pass

**TEST REPORT**

**9. APPENDIX I - PHOTOS OF TEST SETUP**

Conducted disturbance voltage at mains ports



Emission at Telecommunications / network Ports



**TEST REPORT**

Radiated emission (30 MHz–1000 MHz)



Harmonic of current/Flicker



**TEST REPORT**

Inject current immunity



Radiated EM field immunity





**TEST REPORT**

Surge Immunity



EFT Immunity



**TEST REPORT**

Power frequency magnetic field immunity

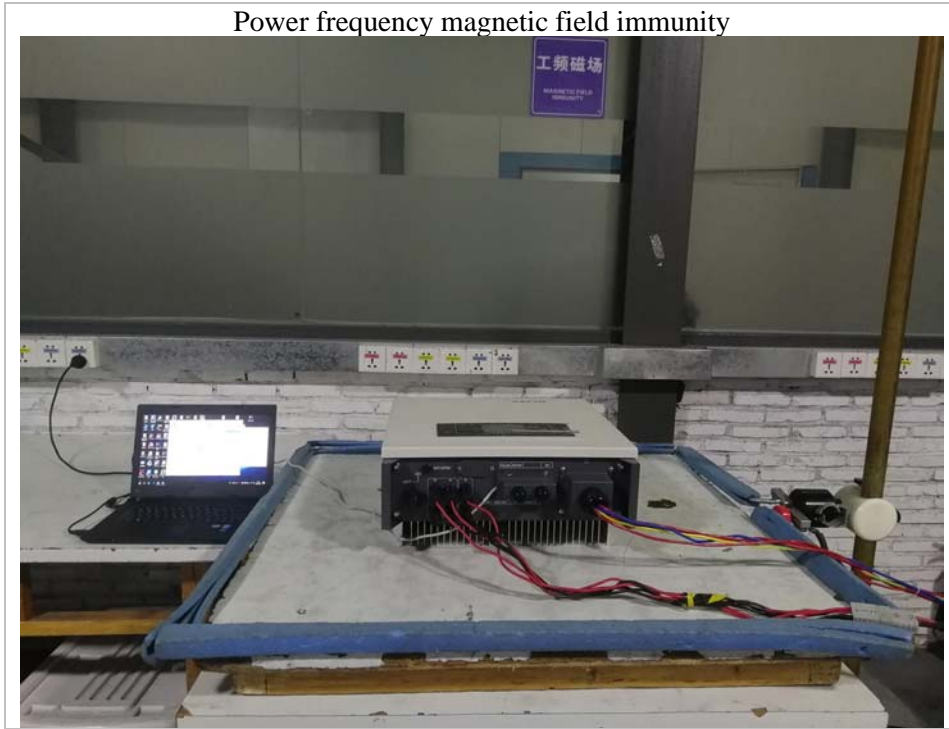

**TEST REPORT**

**10. APPENDIX II – PHOTOS OF EUT**

Appendix 1: Photos



Front view

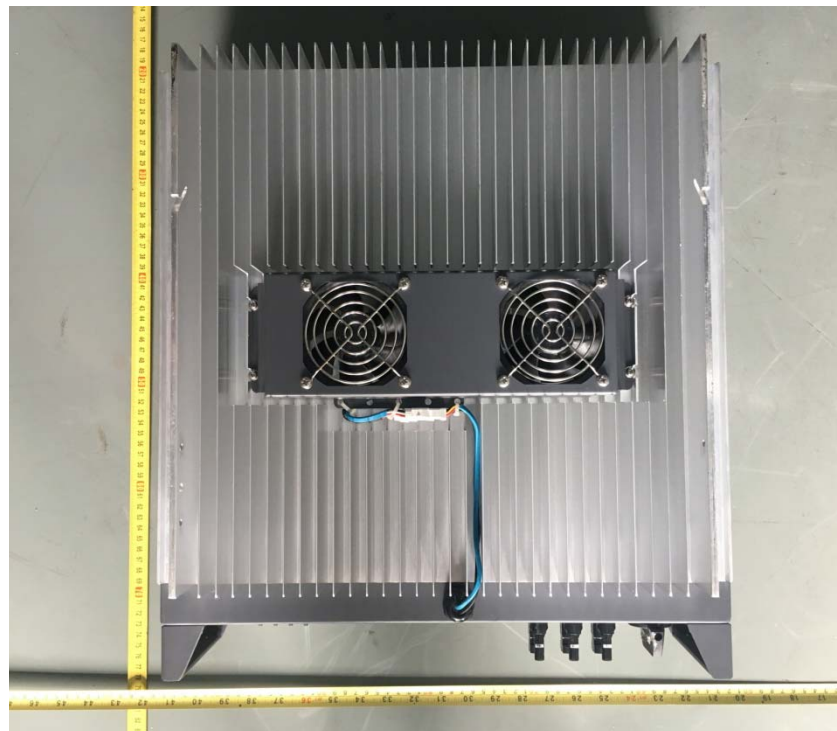

Back view

**TEST REPORT**



Connection view



Internal view

**TEST REPORT**



Internal view (for model SOFAR 10000TL-G2, SOFAR 12000TL-G2)



Internal view (for model SOFAR 15000TL-G2)

**TEST REPORT**



Internal view



Internal view

**TEST REPORT**

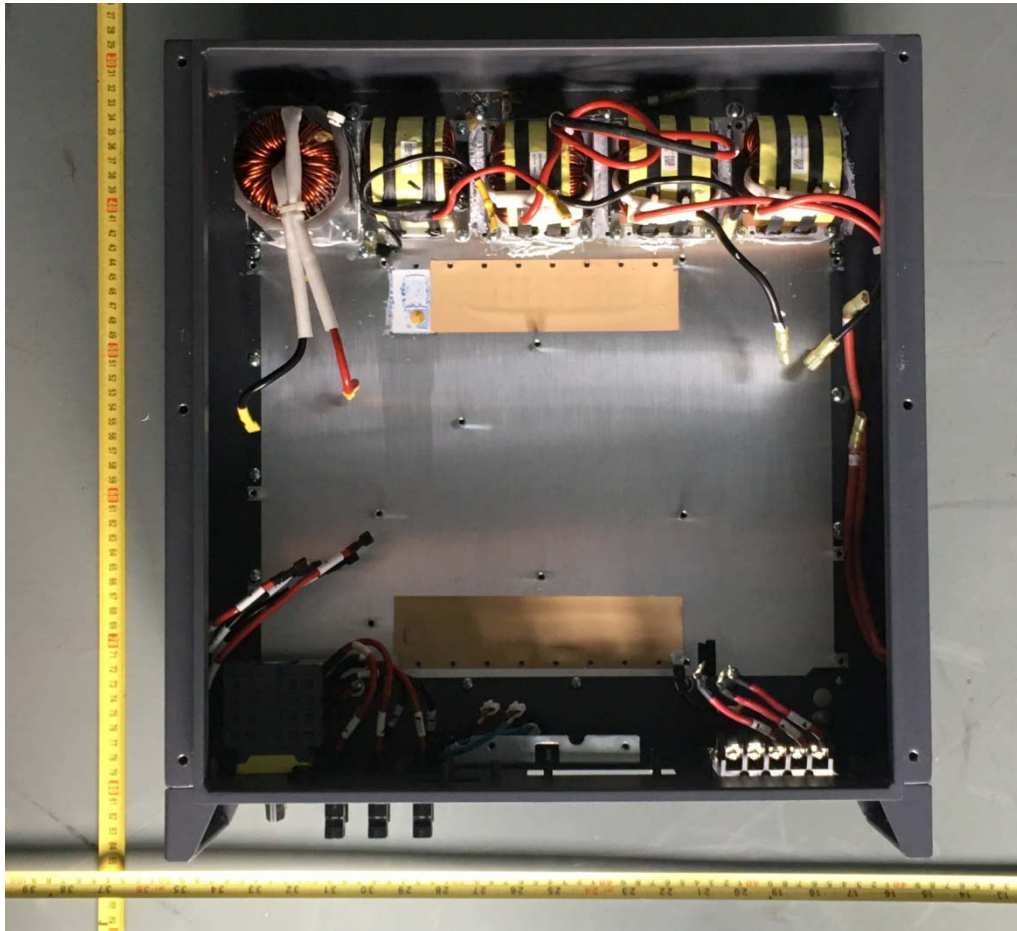

Internal view



Earthing terminal

**TEST REPORT**

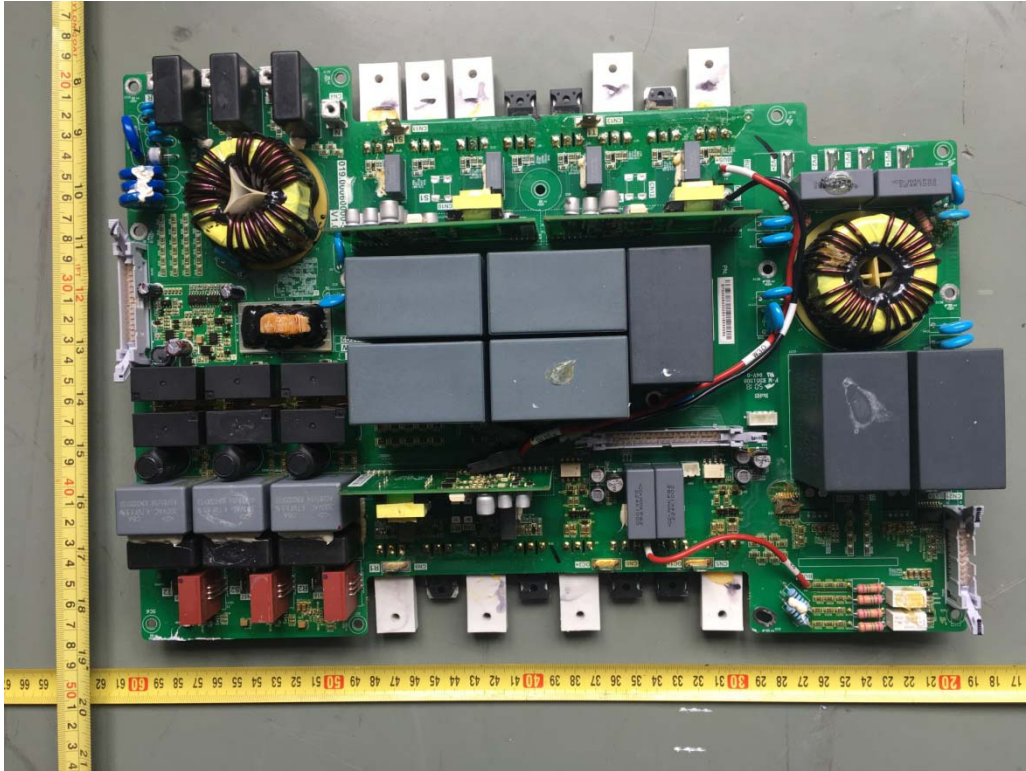

Component side of main board view

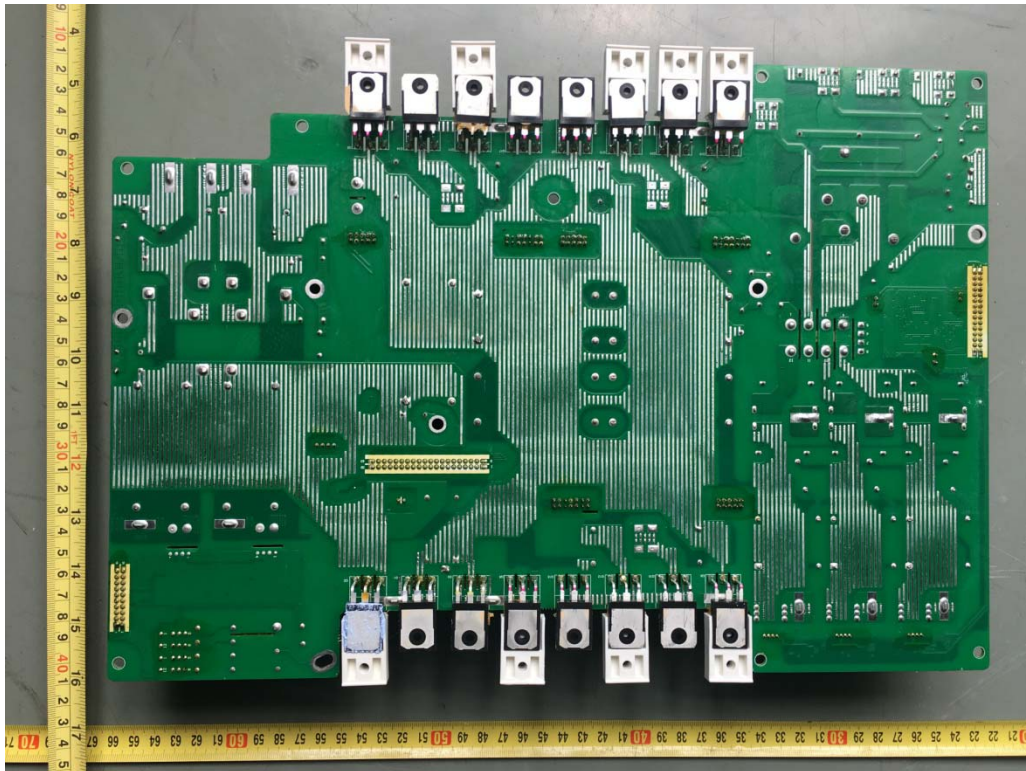

Trace side of main board view



**TEST REPORT**

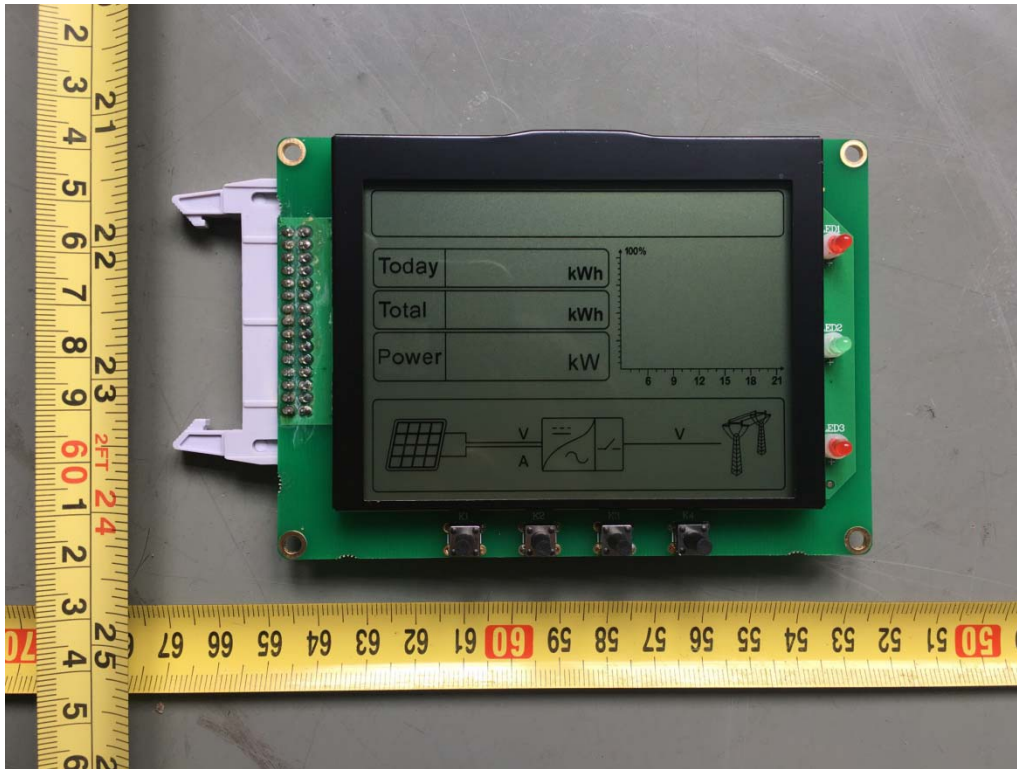

LCD view

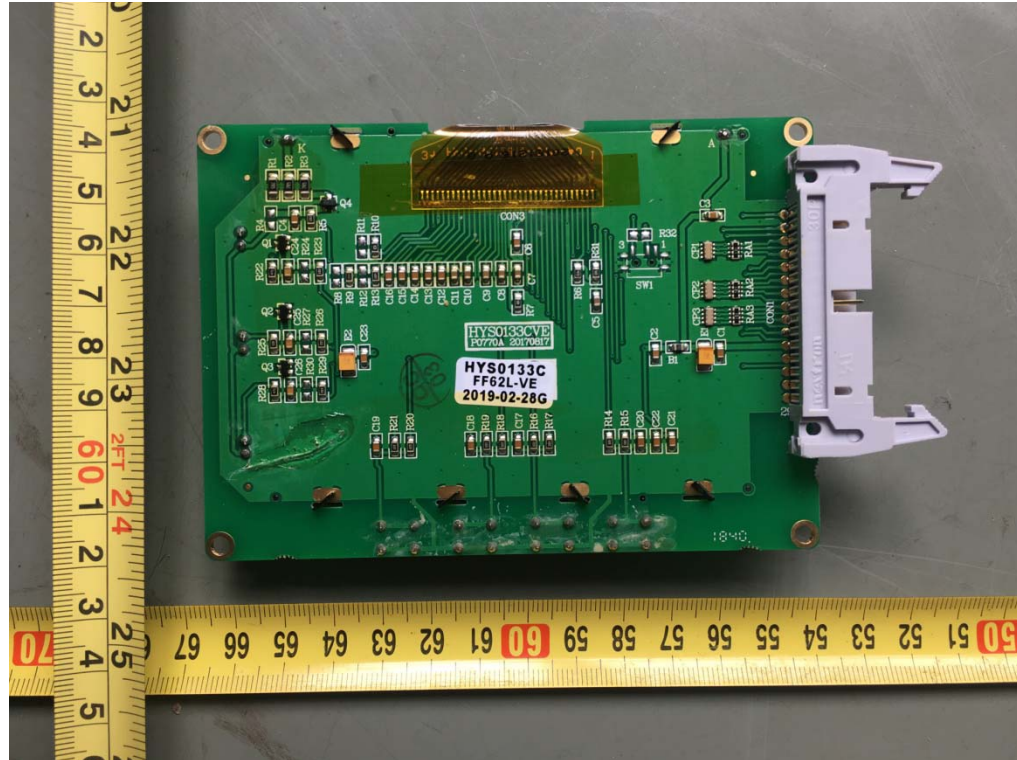

Trace side of LCD view

**TEST REPORT**

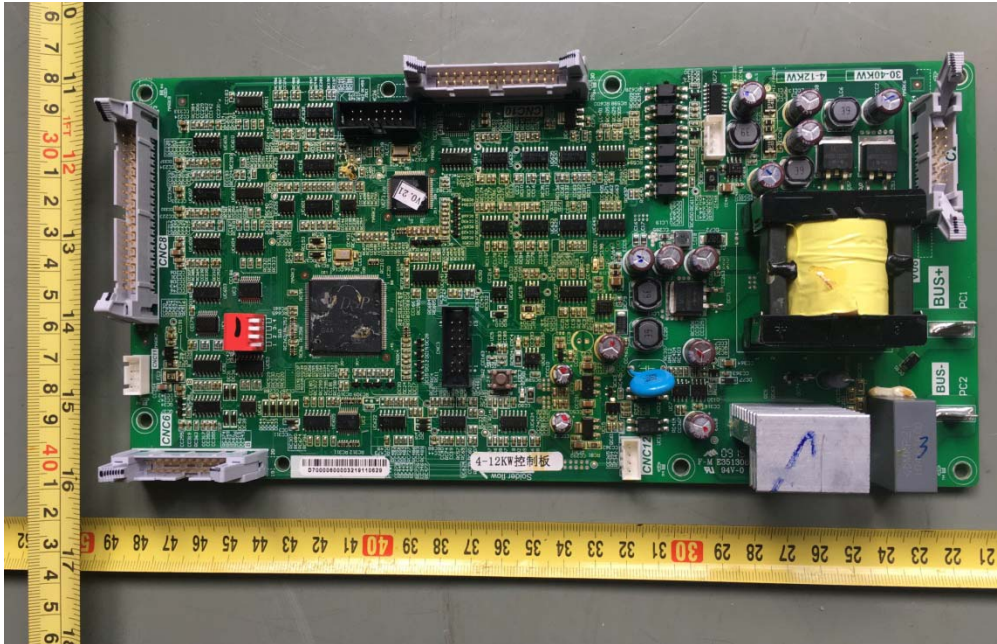

Components side of control board view

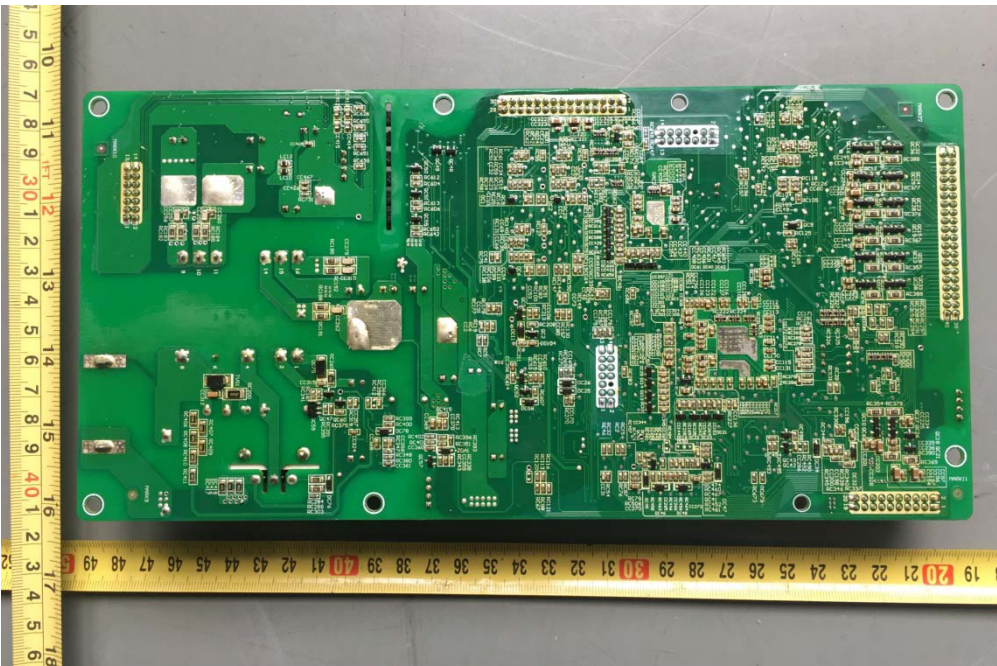

Trace side of control board view

**TEST REPORT**

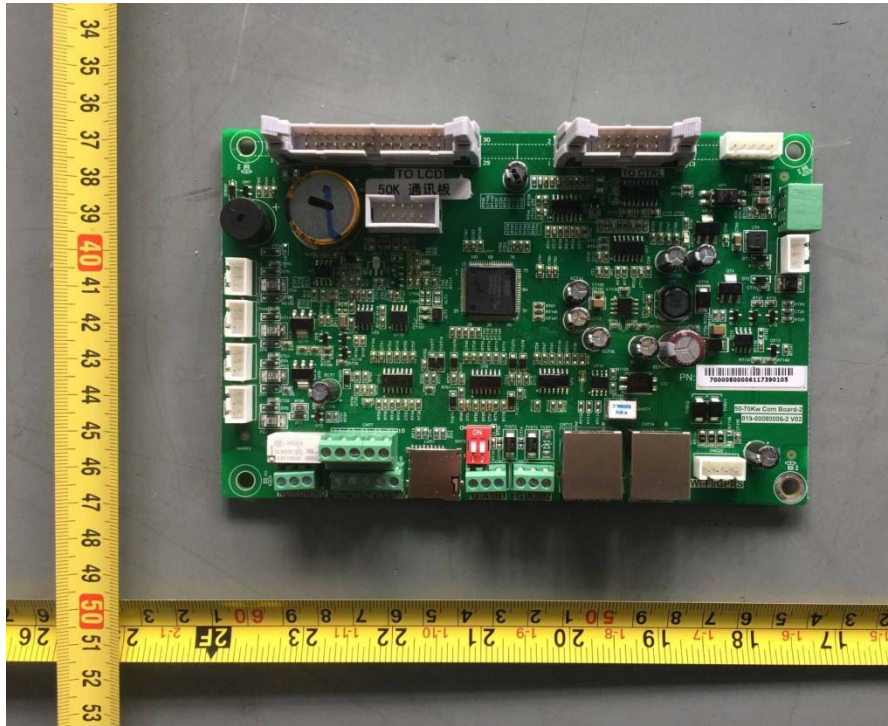

Components side of communication board view

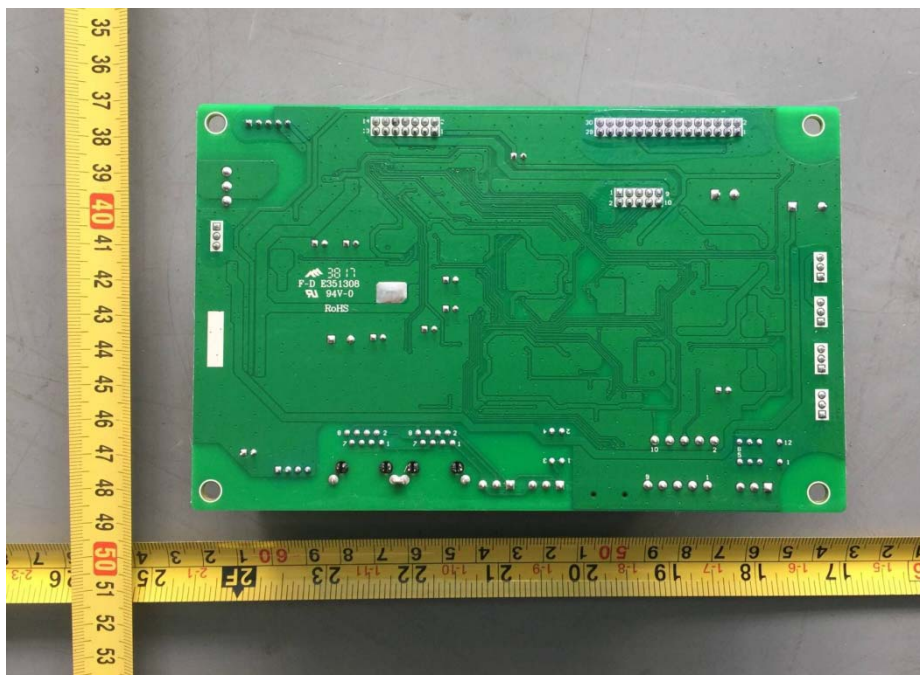

Trace side of communication board view

\*\*\*\*\*End of Report\*\*\*\*\*